

CATEGORIE

CATEGORIES/GRUPPEN

PAGINA

PAGE/SEITE

SETTORE

SECTORS/SECTEURS/SEKTOREN

LAMPADE PER SALA OPERATORIA.

SURGICAL & OPERATING ROOM BULBS.

LAMPES POUR BLOC OPERATOIRE.

LAMPEN FÜR OPERATIONSLICHTEINRICHTUNGEN.

3-14



LAMPADE OTTICHE E A FESSURA. LAMPADE PER MICROSCOPI, COLPOSCOPI, MICROSCOPI OPERATORI; COLLIMATORI E ALTRI USI.

SLIT AND OPTICAL BULBS. BULBS FOR MICROSCOPES, COLPOSCOPES, OPERATING MICROSCOPES, COLLIMATORS AND OTHER USES.

LAMPES A FENTE ET OPTIQUES. LAMPES POUR MICROSCOPES, COLPOSCOPES, MICROSCOPES OPERATOIRES, COLLIMATEURS ET AUTRES USAGES.

OPTISCHE UND SCHLITZLAMPEN. MIKROSKOPIERLAMPEN
LAMPEN FÜR KOLPOSKOPEN, OPERATIONS-MIKROSKOPE
KOLLIMATOREN UND ANDEREN GEBRÄUCHE.

15-27



LAMPADE PER ENDOSCOPIA, OTTICA, MICROSCOPIA, FONTI LUMINOSE, ANALIZZATORI, OFTALMOSCOPIA ED ALTRI USI.

OPTICAL AND OPHTHALMIC BULBS. BULBS FOR ENDOSCOPY, MICROSCOPY, LIGHT SOURCES, ANALYZERS AND OTHER USES.

LAMPES OPTIQUES ET OPHTHALMIQUES. LAMPES POUR ENDOSCOPIE, MICROSCOPIE, SOURCES LUMINEUSES, ANALYSEURS ET AUTRES USAGES.

OPTISCHE UND OPHTHALMISCHE LAMPEN. LAMPEN FÜR ENDOSKOPIE, MIKROSKOPIE, LICHTSQUELLEN, ANALYSATOREN, OPHTHALMOSKOPIE UND ANDEREN GEBRÄUCHE.

29-37

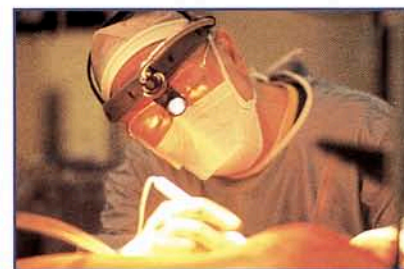

LAMPADE PER VIDEOENDOSCOPIA, LAPAROSCOPIA, MICROSCOPIA, FOTOTERAPIA, LAMPADE GERMICIDA E PORTALAMPADE.

BULBS FOR VIDEO ENDOSCOPY, LAPAROSCOPY, MICROSCOPY AND PHOTOTHERAPY. GERMICIDAL BULBS AND LAMP HOLDERS.

LAMPES POUR VIDEO ENDOSCOPIE, LAPAROSCOPIE, MICROSCOPIE ET PHOTOTHERAPIE. LAMPES GERMICIDES ET DOUILLES.

LAMPEN FÜR VIDEO ENDOSKOPIE, LAPAROSKOPIE, MIKROSKOPIE, PHOTOTHERAPIE, ENTKEIMUNGSLAMPEN UND FASSUNGEN.

39-47

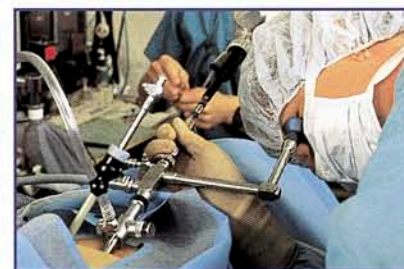

Q[®] **GUERRA**
www.lampsguerra.com

Q[®] **GUERRA**
www.lampsguerra.com

Q[®] **GUERRA**
www.lampsguerra.com

LAMPADRE PER SALA OPERATORIA.

SURGICAL & OPERATING ROOM BULBS.

LAMPES POUR BLOC OPERATOIRE.

LAMPEN FÜR OPERATIONSLICHTEINRICHTUNGEN.

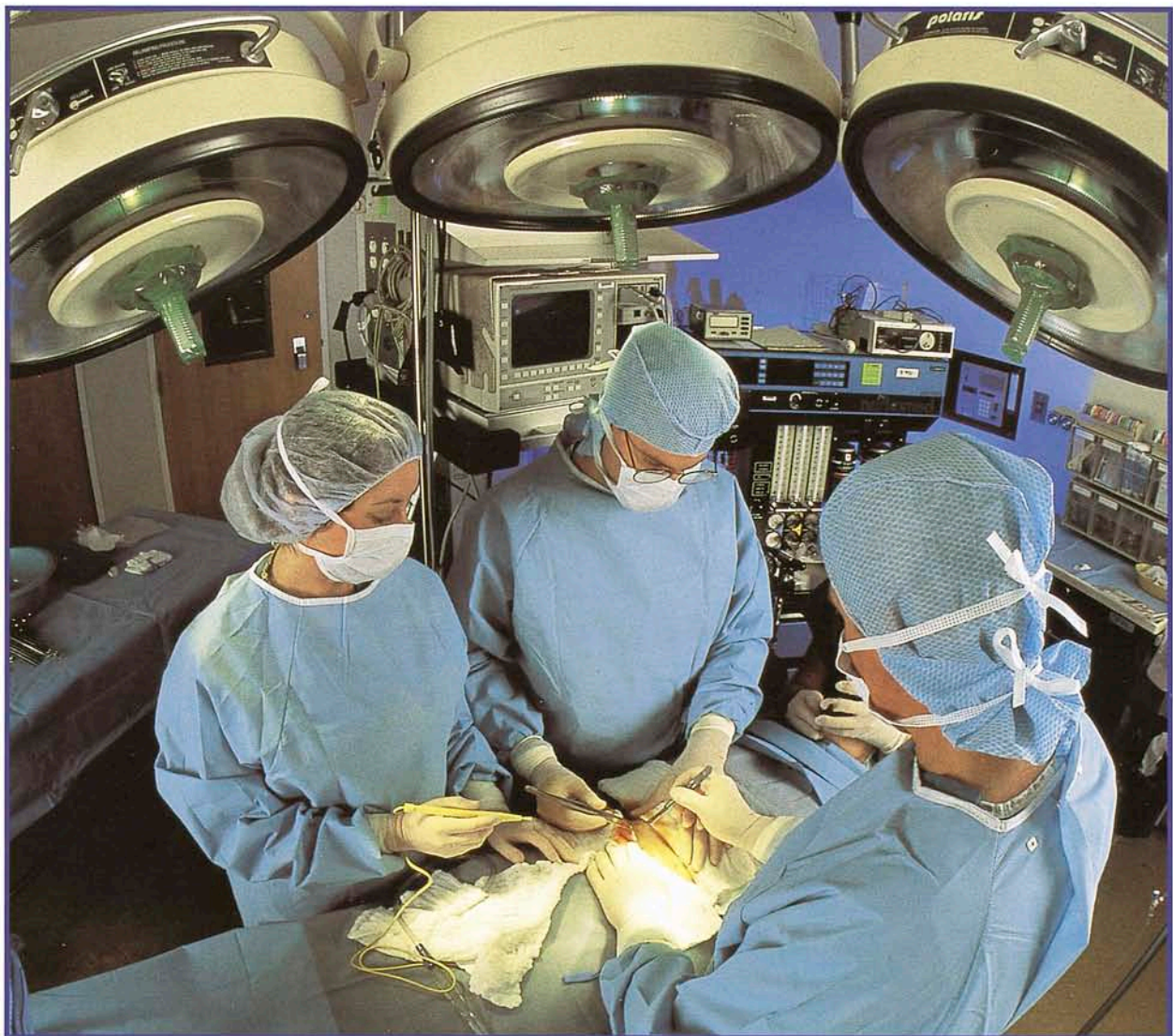



 I prodotti Guerra, ove applicabile, sono conformi alla direttiva 93/42/CEE (**attuazione direttiva sui dispositivi medici**) e 73/23/CEE (relativa alle garanzie di sicurezza del materiale elettrico) per quanto concerne la marcatura CE.

L'azienda è registrata c/o il Ministero della Sanità secondo l'articolo 13 del decreto legislativo del Governo n. 46 del 24-2-1997. Rif. Fascicolo tecnico Guerra rev. 0 Marzo 1999.

 Guerra products, where applicable, comply with the directive 93/42/CEE (**carrying out the directive in medical devices**) and 73/23/CEE (relative to the security guarantees of electric materials) concerning the CE mark.

The company is registered c/o Ministero della Sanità (the Health Office) according to article 13 of the decree law number 46 of 24-2-97. Ref. Technical file Guerra rev. 0 March 1999.

 Les produits Guerra, où applicable, sont conformes à la directive 93/42/CEE (**exercice de la directive sur les dispositifs médicaux**) et 73/23/CEE (relative aux garanties de sécurité du matériel électrique) en ce qui concerne le marquage CE.

L'entreprise est inscrite auprès du Ministère de la Santé conformément à l'article 13 du décret législatif du Gouvernement n. 46 du 24-2-1997. Réf. Dossier technique Guerra rev. 0 Mars 1999.

 Die Produkten Guerra, wenn anwendbar, entsprechen die Richtlinien 93/42/CEE (**Verwirklichung der Richtlinie über ärztliche Vorrichtungen**) und 73/23/CEE (über Sicherheitsgewährleistungen) mit Beziehung auf die EC Kennzeichnung.

Die Firma wurde bei der Gesundheitsministerium nach dem Artikel 13 der Rechtsverordnung n. 46 vom 24-2-1997 registriert. Bez. technischen Aktenbündel Guerra Rev. 0 März 1999.

 Los productos Guerra, donde aplicable, respetan la directiva 93/42/CEE (**actuación directiva sobre los dispositivos médicos**) y 73/23/CEE (referente a las garantías de seguridad del material eléctrico) por lo que respecta a la marca CE.

La empresa está registrada c/o el Ministerio de la Sanidad según el artículo 13 del decreto legislativo del Gobierno n. 46 del 24-2-1997. Ref. Expediente técnico Guerra rev. 0 Marzo 1999.

 Per i disegni tecnici presenti sul catalogo vigono le tolleranze DIN 7168 E riportate nella tabella sotto.

 For technical drawings present on the catalogue are in forced the tolerances DIN 7168 E reported in table below.

 Pour les dessins techniques présents sur le catalogue, les tolérances DIN 7168 E indiquées dans le tableau ci-dessous sont en vigueur.

 Für die technischen Zeichnungen am Katalog sind die Toleranzen DIN 7168 E gültig, die in der folgenden Tabelle eingetragen sind.

 Por lo que respecta a los diseños técnicos presentes en el catálogo, valen las tolerancias DIN 7168 E indicadas en la tabla a continuación.

Ref. DIN 7168 E

Deviations in mm for the nominal size range in mm												
degree of accuracy	0,5 up to 3	over 3 up to 6	over 6 up to 30	over 30 up to 120	over 120 up to 400	over 400 up to 1000	over 1000 up to 2000	over 2000 up to 4000	over 4000 up to 8000	over 8000 up to 12000	over 12000 up to 16000	over 16000 up to 20000
g (coarse)	± 0,15	± 0,2	± 0,5	± 0,8	± 1,2	± 2	± 3	± 4	± 5	± 6	± 7	± 8

ART. No. ART. No. BEST. NR. CODICE	TYPE REF. TYP TIPO	VOLTAGE VOLTS VOLTS VOLT	WATTAGE WATTS WATTS WATT	BASE CULOT SOCKET BASE	LUMENS LUMENS LUMENS LUMEN.	LIFE DUREE LEBENSDAUER DURATA	QY/PACK PIECES/CARTON STK/KARTON IMB.	FIG. No. FIG. No. BILD NR. FIG. n.
0079/0	H016544	24	40	BX22D	500	600	10	1
0079/1	H016678	24	50	BX22D	600	600	10	1
0079/2	H018251	220	50	BX22D	450	500	10	1
0079/3*	H018250	220	50	BX22D	400	500	10	1
0079/4	H018252	240	50	BX22D	450	500	10	1
0079/5	H016578	125	50	BX22D	400	460	10	1
0079/6	H016679	110	50	BX22D	400	440	10	1
0079/E	—	220	50	E27	450	500	10	1

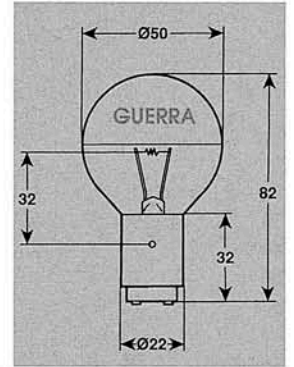

0178/3	A.5904	24	40	BA15D	500	600	10	2
0178/4	A.5905	24	50	BA15D	600	600	10	2
0178/5	H016344	125	30	BA15D	280	500	10	2

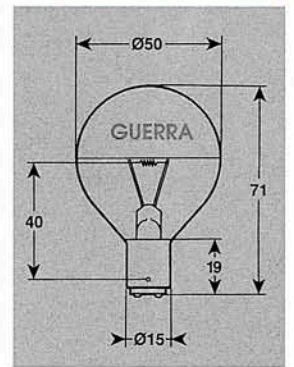
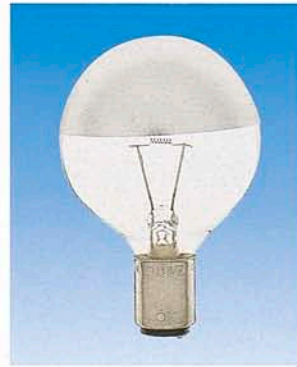

0178/FH	H	24	35	BA15D	600	1000	10	3
---------	---	----	----	-------	-----	------	----	---

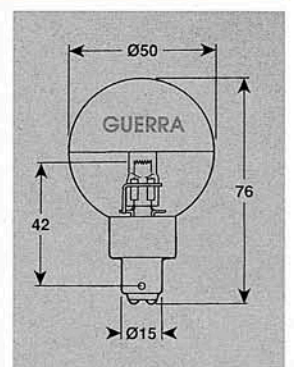

0178/3F	—	24	40	BA15D	500	600	10	4
---------	---	----	----	-------	-----	-----	----	---

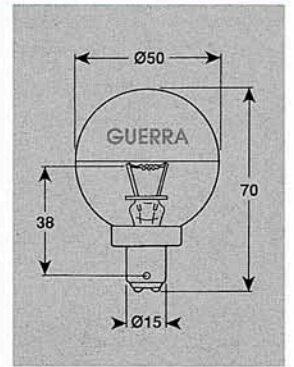
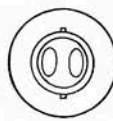

0178/L1	3706	24	40	BA15D	500	600	10	5
0178/L5	3701	24	50	BA15D	600	600	10	5

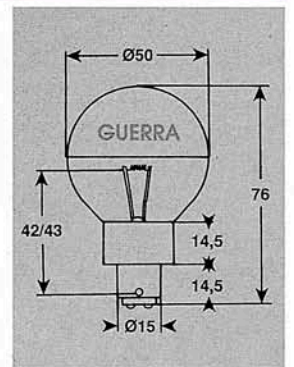
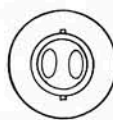

* = SATINATA/FROSTED/MAT/MATTIERT
 H = ALOGENA/HALOGEN/HALOGENE/HALOGEN

ART. No. ART. No. BEST. NR. CODICE	TYPE REF. TYP TIPO	VOLTAGE VOLTS VOLTS VOLT	WATTAGE WATTS WATTS WATT	BASE CULOT SOCKET BASE	LUMENS LUMENS LUMENS LUMEN.	LIFE DUREE LEBENSDAUER DURATA	QY/PACK PIECES/CARTON STK./KARTON IMB.	FIG. No. FIG. No. BILD NR. FIG. n.
---	-----------------------------	-----------------------------------	-----------------------------------	---------------------------------	--------------------------------------	--	---	---

0277/4	-	24	40	BA15D	500	600	10	6
0277/5	A.5901	24	50	BA15D	600	600	10	6

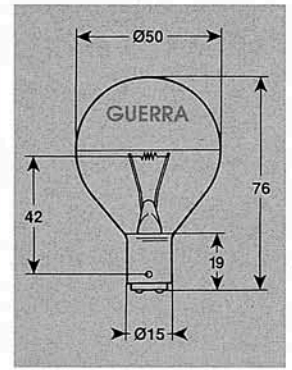

0376/1	H016164	24	25	BA15D	400	500	10	7
0376/2	A.6004	24	30	BA15D	450	600	10	7
0376/4	H016372	24	40	BA15D	500	600	10	7
0376/6	-	24	50	BA15D	600	600	10	7
0376/7	H016191	12	25	BA15D	370	400	10	7
0376/9	R.16192	12	35	BA15D	400	400	10	7
0376/11	H016170	110	30	BA15D	300	500	10	7

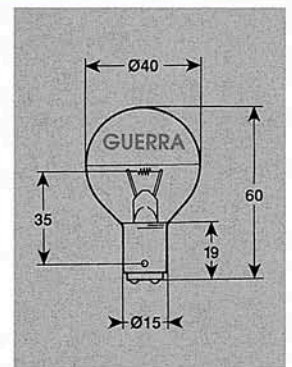

0376/H	-	24	20	BA15D	360		10	8
--------	---	----	----	-------	-----	--	----	---

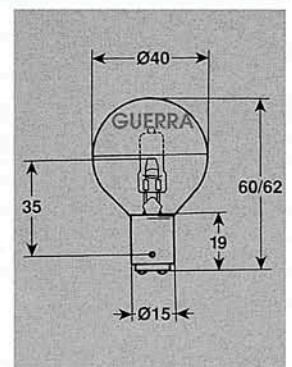
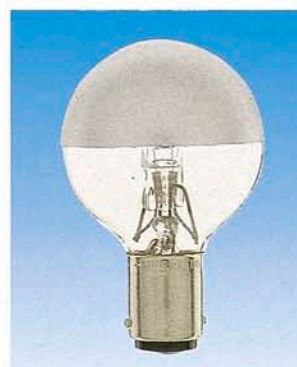

0574/3	H018550	24	40	BA15D	500	600	10	9
--------	---------	----	----	-------	-----	-----	----	---

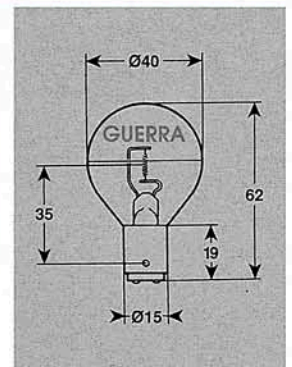
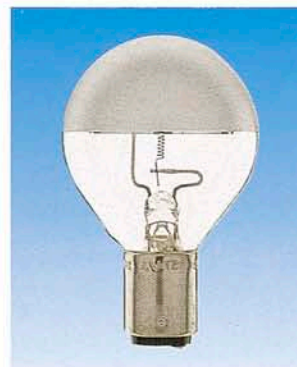

0574/3H	1210	24	40	BA15D	800	1000	10	10
0574/4H	-	24	50	BA15D	950	1000	10	10
0574/5H	-	24	60	BA15D	1100	1000	10	10

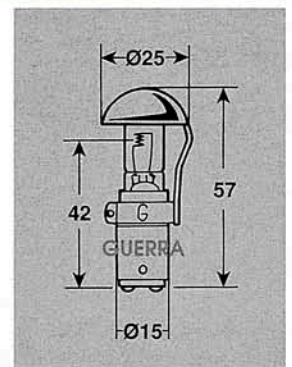

ART. No. ART. No. BEST. NR. CODICE	TYPE REF. TYP TIPO	VOLTAGE VOLTS VOLTS VOLT	WATTAGE WATTS WATTS WATT	BASE CULOT SOCKET BASE	LUMENS LUMENS LUMENS LUMEN.	LIFE DUREE LEBENSDAUER DURATA	QY/PACK PIECES/CARTON STK/KARTON IMB.	FIG. No. FIG. No. BILD NR. FIG. n.
0772/G4	GAL/Z	24	1,4A.	P45T	500	300	10	11
0772/L3	L99	24	1,4A.	P45T	500	300	10	11

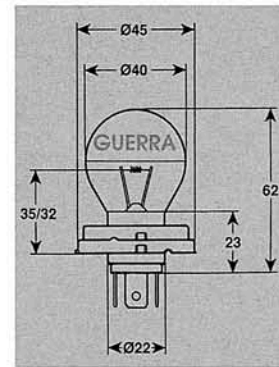
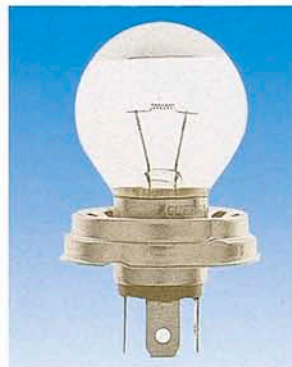
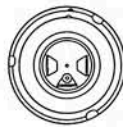

0772/L5	58912	24	50	P45T	860	2000	10	12
0772/L6	58913	24	55	P45T	900	2000	10	12
0772/L7*	58911	24	21	P45T	400	500	10	12
0772/L8*	58911/A	24	25	P45T	480	800	10	12
0772/L9	58911/B	24	35	P45T	700	1000	10	12

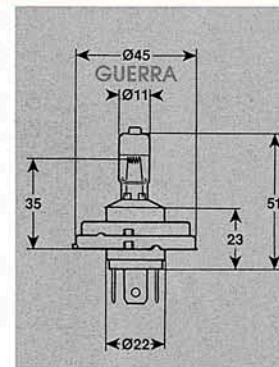
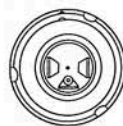

0772/L10	29910	24	35	SPEC.	700	1000	10	13
----------	-------	----	----	-------	-----	------	----	----

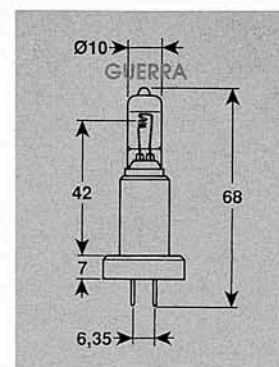
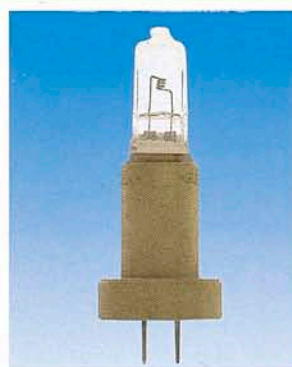

0871/2	-	24	50	BA20D	600	700	10	14
0871/4	-	24	70	BA20D	700	400	10	14
0871/6	-	12	70	BA20D	600	200	10	14

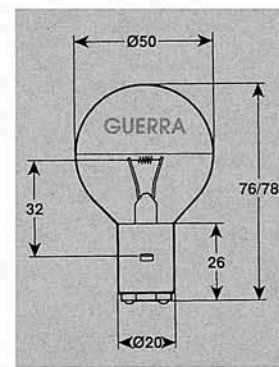

0970/3B	M8891602	24	25	BA20D	450	700	10	15
0970/4	-	24	30	BA20D	500	700	10	15
0970/7	M8695001	24	50	BA20D	600	700	10	15
0970/8	1150/91	24	60	BA20D	650	600	10	15

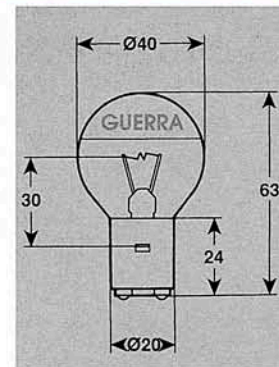

* = ASSIALE/AXIAL/AXIALE/AXIAL
 SPEC. = SPECIALE/SPECIAL/SONDER

ART. No. ART. No. BEST. NR. CODICE	TYPE REF. TYP TIPO	VOLTAGE VOLTS VOLTS VOLT	WATTAGE WATTS WATTS WATT	BASE CULOT SOCKET BASE	LUMENS LUMENS LUMENS LUMEN.	LIFE DUREE LEBENSDAUER DURATA	QY/PACK PIECES/CARTON STK./KARTON IMB.	FIG. No. FIG. No. BILD NR. FIG. n.
---	-----------------------------	-----------------------------------	-----------------------------------	---------------------------------	--------------------------------------	--	---	---

0970/V1	M1521	24	60	BA20D	650	600	10	16
0970/V2	-	24	50	BA20D	600	700	10	16

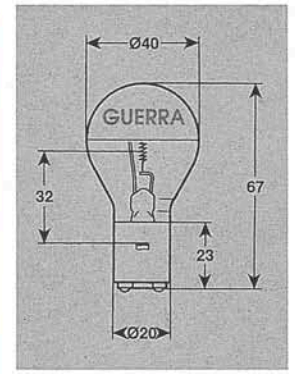

8890/1	8891402	24	50/50	BA22D	-	1000	1	17
--------	---------	----	-------	-------	---	------	---	----

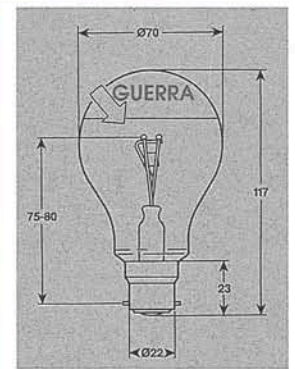
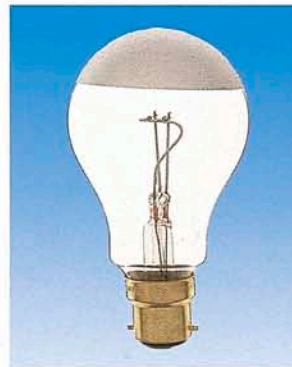
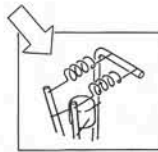

8891/1	8891202	24	75/75	E27/30	-	1000	1	18
--------	---------	----	-------	--------	---	------	---	----

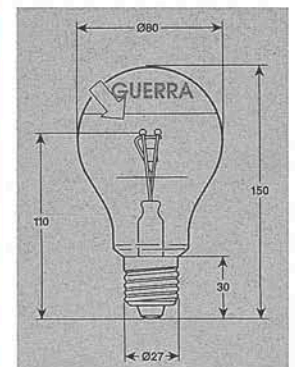
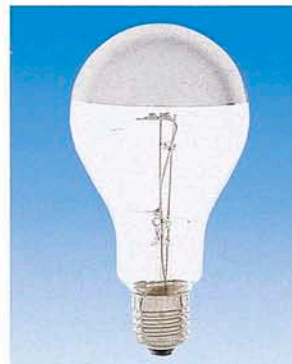
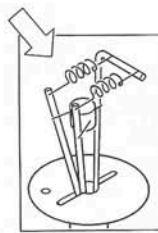

8892/1	8891002	24	100/100	E27/30	-	1000	1	19
--------	---------	----	---------	--------	---	------	---	----

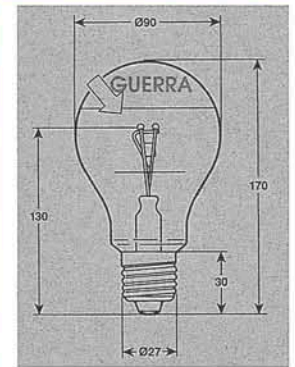
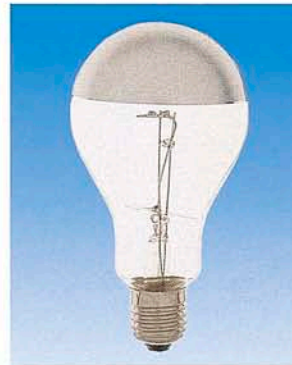
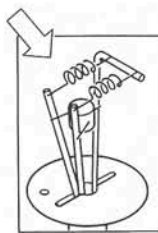

8892/2 *	-	24	150	E27/30	-	300	4	20
8892/3CH	-	24	150	E27/30	-	300	4	20

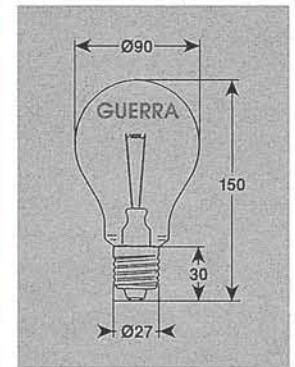

* = SATINATA/FROSTED/MAT/MATTIERT
CH = CHIARA/CLEAR/CLAIRE/KLAR

ART. No. ART. No. BEST. NR. CODICE	TYPE REF. TYP TIPO	VOLTAGE VOLTS VOLTS VOLT	WATTAGE WATTS WATTS WATT	BASE CULOT SOCKET BASE	LUMENS LUMENS LUMENS LUMEN.	LIFE DUREE LEBENSDAUER DURATA	QY/PACK PIECES/CARTON STK/KARTON IMB.	FIG. No. FIG. No. BILD NR. FIG. n.
---	-----------------------------	-----------------------------------	-----------------------------------	---------------------------------	--------------------------------------	--	--	---

8892/4 *	-	230	150	E27/30	-	1000	4	21
----------	---	-----	-----	--------	---	------	---	----



GUERRA

PRODUZIONE LAMPADE SPECIALI
PRODUCTION OF SPECIAL LAMPS
PRODUCTION D'AMPOULES SPECIALES
HERSTELLUNG VON SONDERLAMPEN

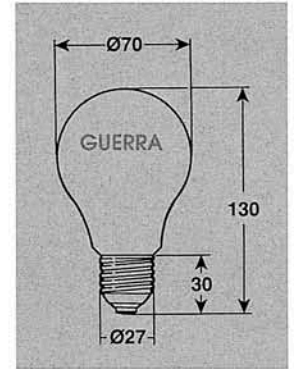

8893/1	HCR145/3B	24	40	G16	500	1000	1	22
--------	-----------	----	----	-----	-----	------	---	----

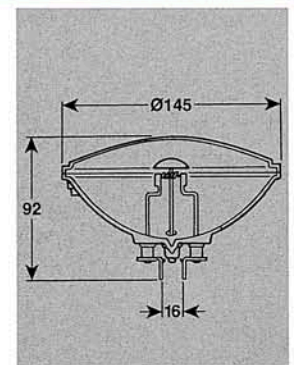
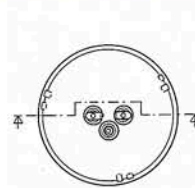

5429/0	-	24	40	BA15D	800	1000	10	23
5429/1	-	24	50	BA15D	900	1000	10	23
5429/2	-	24	150	BA15D	3500	1000	10	23
5429/2B	-	24	100	BA15D	2200	2000	10	23

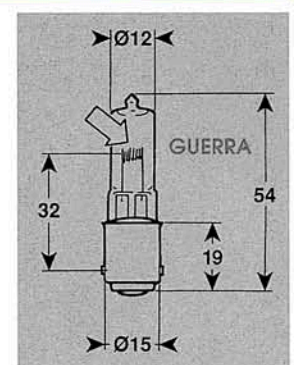
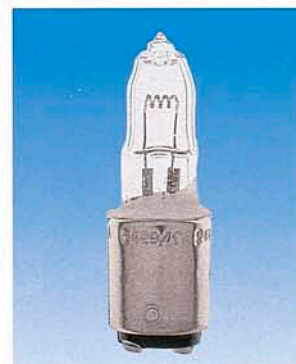

5429/3	ESR	120	100	BA15D	1800	750	10	24
5429/4	ESP	120	150	BA15D	2800	1000	10	24
5429/5	ESS	120	250	BA15D	4850	2000	10	24

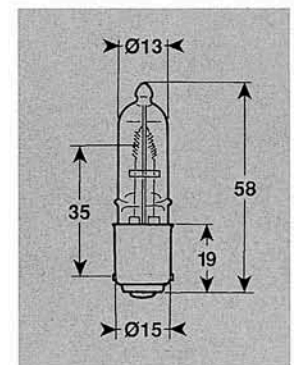
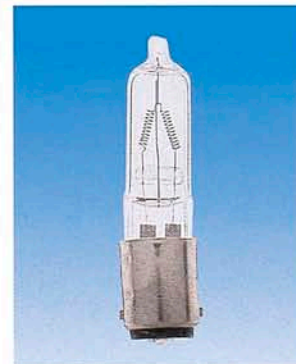

5429/F40	DAIKYO	24	40	BA15D	800	1000	10	25
5429/F50	-	24	50	BA15D	950	1000	10	25

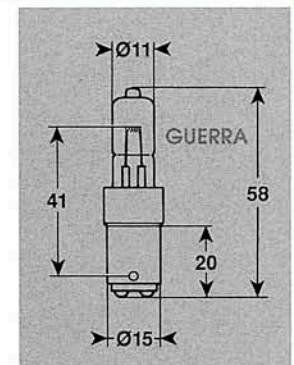
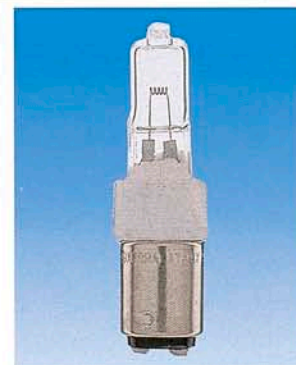

* = SATINATA/FROSTED/MAT/MATTIERT

ART. No. ART. No. BEST. NR. CODICE	TYPE REF. TYP TIPO	VOLTAGE VOLTS VOLTS VOLT	WATTAGE WATTS WATTS WATT	BASE CULOT SOCKET BASE	LUMENS LUMENS LUMENS LUMEN.	LIFE DUREE LEBENSDAUER DURATA	QY/PACK PIECES/CARTON STK/KARTON IMB.	FIG. No. FIG. No. BILD NR. FIG. n.
---	-----------------------------	-----------------------------------	-----------------------------------	---------------------------------	--------------------------------------	--	--	---

5627/3	58915	24	60	PG22	900	1000	10	26
--------	-------	----	----	------	-----	------	----	----

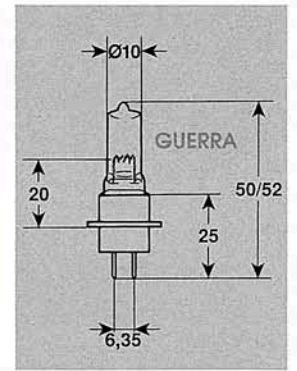
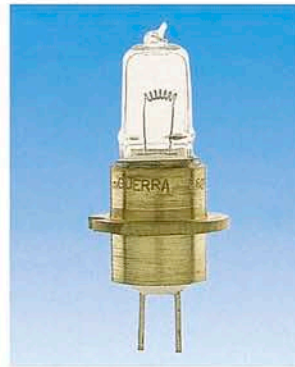
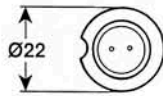

5721/1	FDT	12	100	GY9,5	3000	50	10	27
--------	-----	----	-----	-------	------	----	----	----

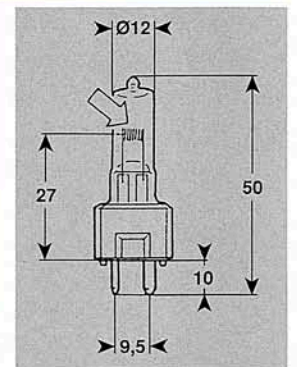
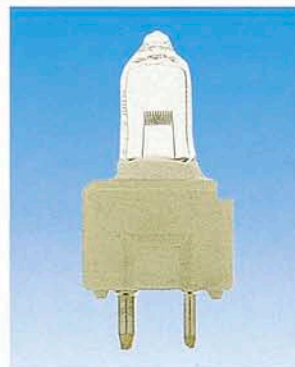
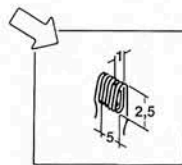

5722/1	FDS	24	150	GY9,5	5000	50	10	28
--------	-----	----	-----	-------	------	----	----	----

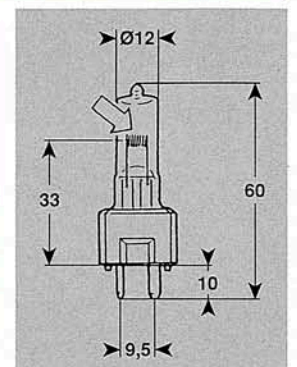
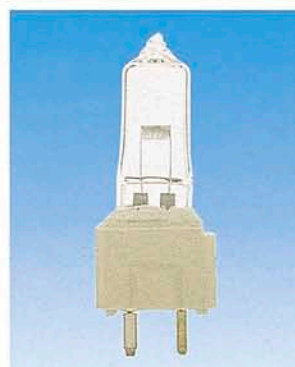
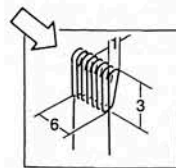

5726/1	SPEC.	24	150	GY9,5	3400	800	10	29
--------	-------	----	-----	-------	------	-----	----	----

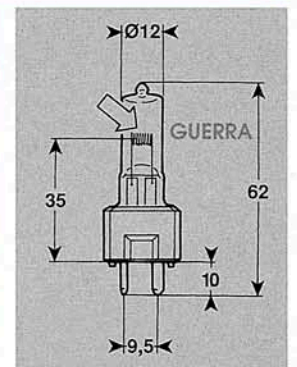
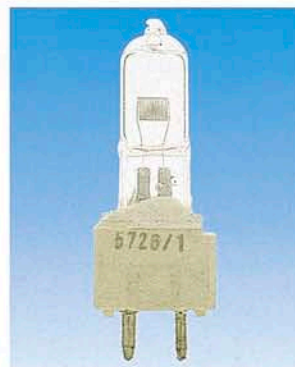
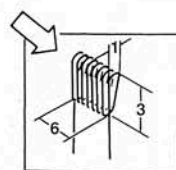

5726/SM	P-129362-228	22	220	GY9,5	4100	300	10	29/A
5727/SM	P-128249-001	33	230	GY9,5	4500	300	10	29/A
5727/6	6,6A200W	6,6A.	220	GY9,5	4300	500	10	29/A

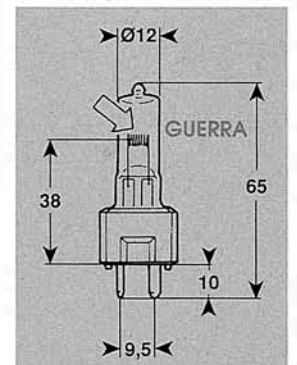
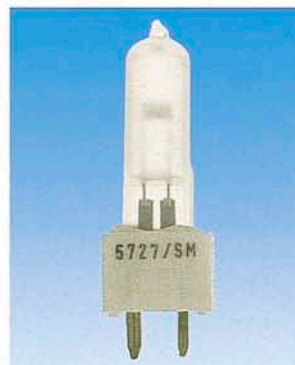

SPEC. = SPECIALE/SPECIAL/SONDER
 SM = SATINATA/FROSTED/MAT/MATTIERT
 A. = AMPER/AMPERE

ART. No. ART. No. BEST. NR. CODICE	TYPE REF. TYP TIPO	VOLTAGE VOLTS VOLTS VOLT	WATTAGE WATTS WATTS WATT	BASE CULOT SOCKET BASE	LUMENS LUMENS LUMENS LUMEN.	LIFE DUREE LEBENSDAUER DURATA	QY/PACK PIECES/CARTON STK/KARTON IMB.	FIG. No. FIG. No. BILD NR. FIG. n.
5924/5A	EVC	24	250	G.6,35	8400	300	10	30
5924/5M	EVC	24	250	G.6,35	8200	300	10	30
5924/4A	-	24	150	G.6,35	4500	300	10	30
5924/7	86-910-00	22,8	250	G.6,35	8000	500	10	30
5924/8	-	24	150	G.6,35	3450	1000	10	30

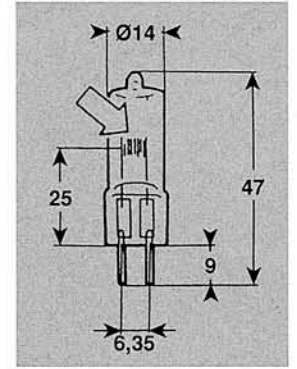
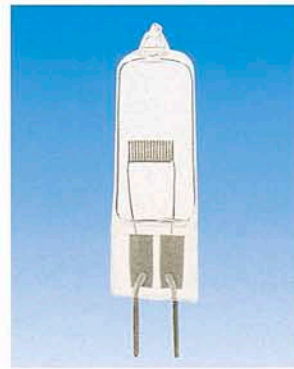
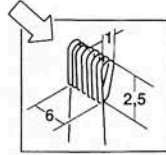

6023/1	-	24	100	X-514		1000	10	31
6023/2	H6950	24	120	X-514	3000	200	10	31

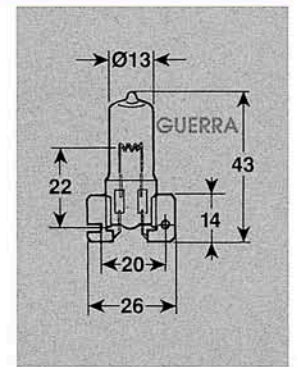
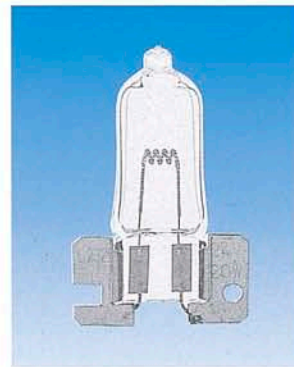

6024/1	-	24	100	SPEC.	2300	1000	10	32
6024/2	-	24	140	SPEC.	3400	500	10	32

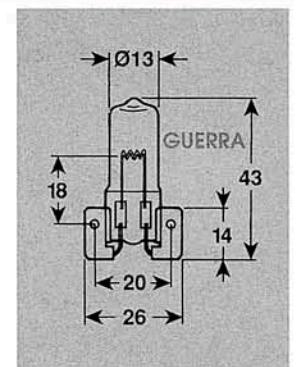
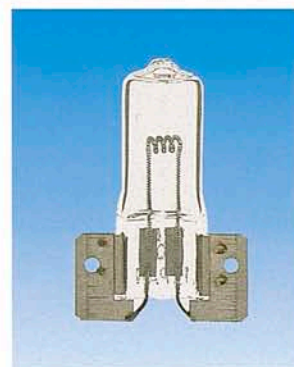

6221/SM	104316	24	70	X-511	1250	1000	10	33
6221/0	104316	24	70	X-511	1350	1000	10	33
6221/1	104316	24	80	X-511	1600	1000	10	33
6221/3	153091	24	100	X-511	2200	1000	10	33

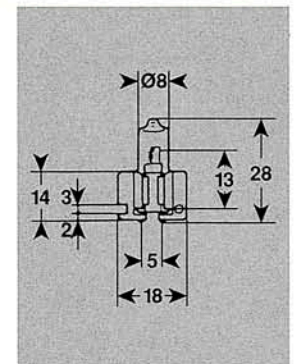
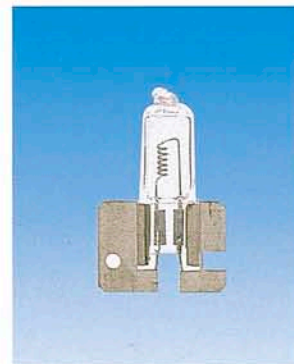

6222/1	-	24	80	X-513	1600	1000	10	34
--------	---	----	----	-------	------	------	----	----

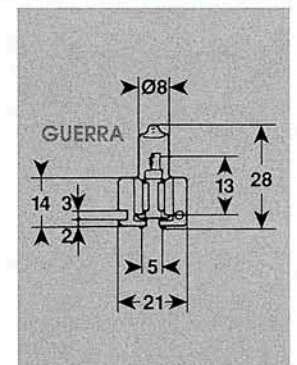
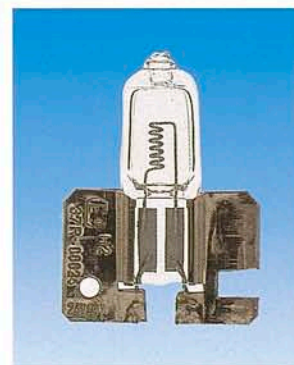

SM = SATINATA/FROSTED/MAT/MATTIERT
 SPEC. = SPECIALE/SPECIAL/SONDER

ART. No. BEST. NR. CODICE	TYPE REF. TYP TIPO	VOLTAGE VOLTS VOLTS VOLT	WATTAGE WATTS WATTS WATT	BASE CULOT SOCKET BASE	LUMENS LUMENS LUMENS LUMEN.	LIFE DUREE LEBENSDAUER DURATA	QY/PACK PIECES/CARTON STK/KARTON IMB.	FIG. No. FIG. No. BILD NR. FIG. n.
6419/2	-	22,8	120	G.6,35	2800	300	10	35
6419/2A	906-24	22,8/24	150	G.6,35	3450	1000	10	35
6419/2B	-	24	220	G.6,35	4100	500	10	35

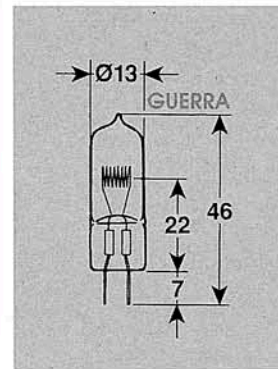
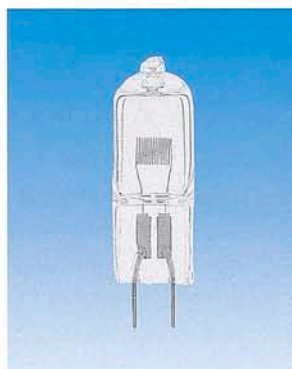
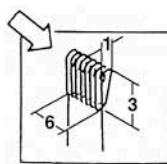

6419/TS	1660	24	50	G.6,35	850	2000	10	36
6419/1	905-24	24	100	G.6,35	2000	2000	10	36
6419/3B	-	22,8	110	G.6,35	2600	1000	10	36
6419/3	H018769	22,8	40	G.6,35	800	1000	10	36
6419/3A	H018566	22,8	50	G.6,35	950	1000	10	36
6419/4	H018576	24	50	G.6,35	1050	1000	10	36
6419/5	-	24	50	G.6,35	900	2000	10	36
6419/6	-	12	35	G.6,35	600	2000	10	36
6419/7	-	12	50	G.6,35	950	2000	10	36

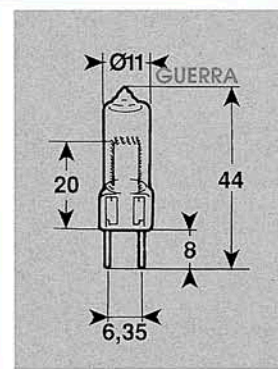
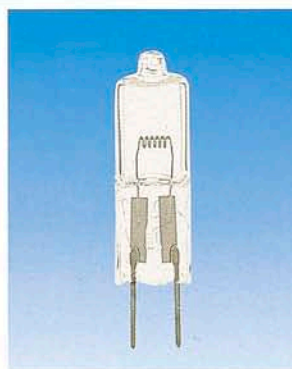

6419/AX1	-	22,8	40	G.6,35	800	1000	10	37
6419/AX2	-	22,8	50	GY6,35	1000	1000	10	37
6419/AX3	-	24	35	GY6,35	500	2000	10	37
6419/AX4	-	24	75	GY6,35	1500	2000	10	37
6419/AX5	-	24	50	GY6,35	750	2000	10	37
6419/AX6	-	12	35	GY6,35	600	2000	10	37
6419/AX7	-	12	50	GY6,35	950	2000	10	37
6419/AX8	-	12	75	GY6,35	1600	2000	10	37

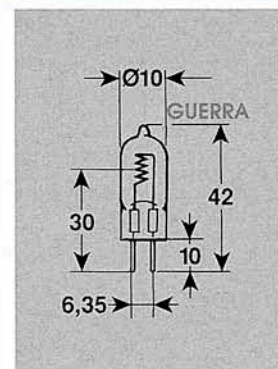
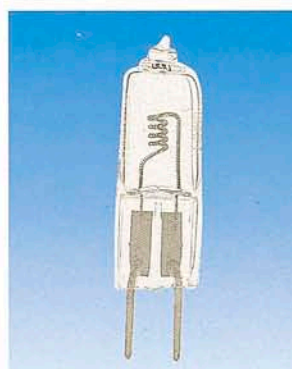

6601/1	M115282	22,8	50	G.6,35	1000	1000	10	38
6601/2	-	24	55	G.6,35	1150	1000	10	38

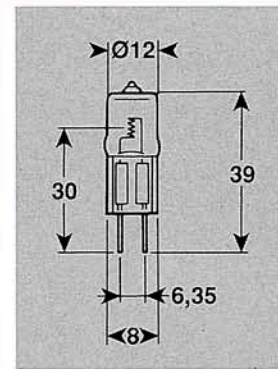
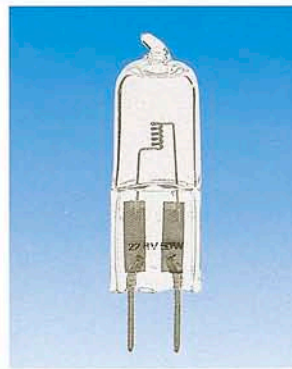

6701/1	SH.37	24	35	E.11	680	1000	10	39
6701/2	SH.42	24	40	E.11	800	1000	10	39
6701/3	SH.52	24	50	E.11	950	1000	10	39
6701/4	SH.62	24	60	E.10	1200	1000	10	39

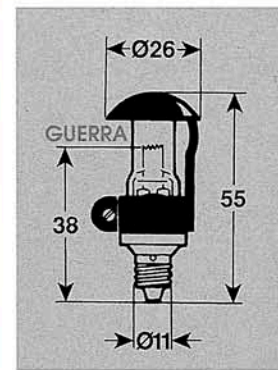

AX = ASSIALE/AXIAL/AXIALE/AXIAL
TS = TESTA SATINATA/FROSTED TOP/TETE MATE/MATTIERTER KOPF

ART. No. ART. No. BEST. NR. CODICE	TYPE REF. TYP. TIPO	VOLTAGE VOLTS VOLTS VOLT	WATTAGE WATTS WATTS WATT	BASE CULOT SOCKET BASE	LUMENS LUMENS LUMENS LUMEN.	LIFE DUREE LEBENSDAUER DURATA	QV/PACK PIECES/CARTON STK/KARTON IMB.	FIG. No. FIG. No. BILD NR. FIG. n.
6701/5	SH100	24	100	E10	2200	1000	10	40/A

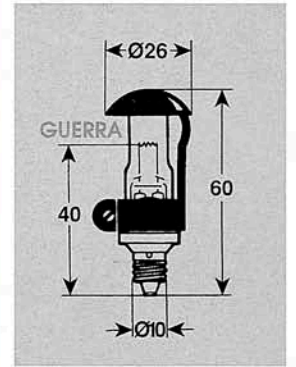

6702/1	DKK24501	24	50	G.8	1000	500	10	41
--------	----------	----	----	-----	------	-----	----	----

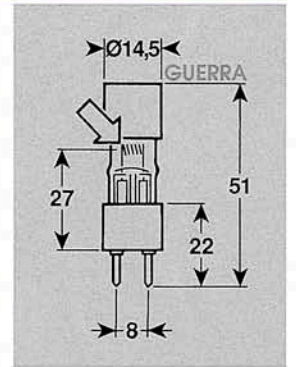
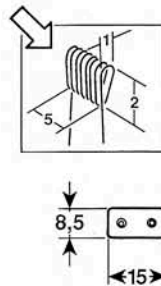

6702/2		24	55	G.6,35	1000	500	10	42
--------	--	----	----	--------	------	-----	----	----

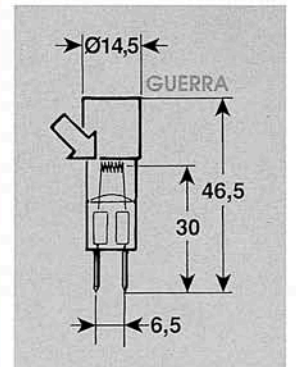
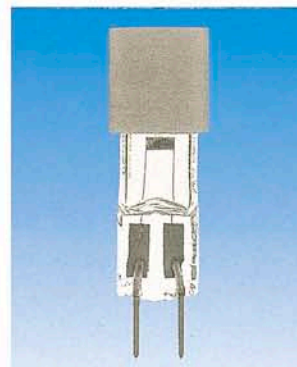
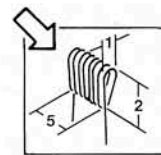

6703/1	-	24	50	G.6,35	900	1000	10	43
6703/AX	-	12	20	G.4	350	2000	10	43

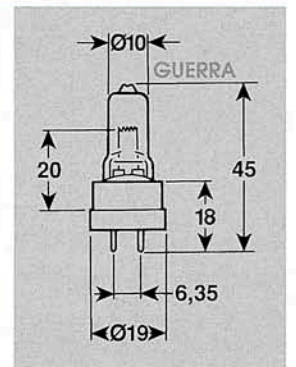
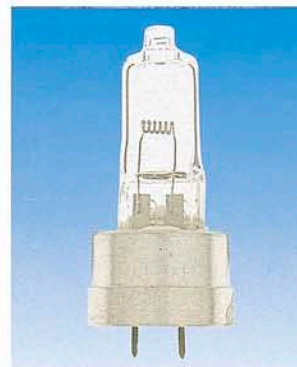

6704/1	MILLION	24	40	G.8	900	1000		44
6704/2	MILLION	24	50	G.8	1000	1000		44

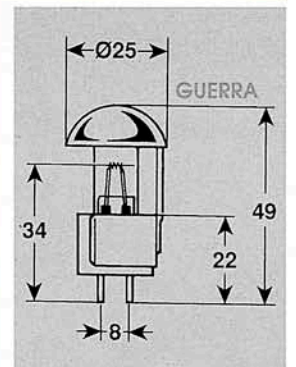
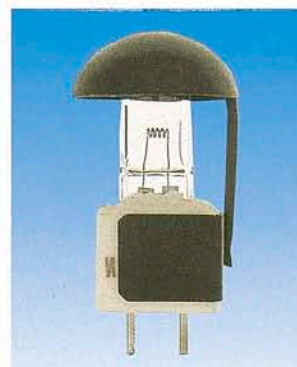
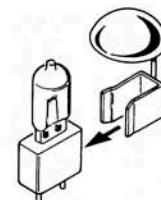

ART. No. ART. No. BEST. NR. CODICE	TYPE REF. TYP TIPO	VOLTAGE VOLTS VOLTS VOLT	WATTAGE WATTS WATTS WATT	BASE CULOT SOCKET BASE	LUMENS LUMENS LUMENS LUMEN.	LIFE DUREE LEBENSDAUER DURATA	QY/PACK PIECES/CARTON STK/KARTON IMB.	FIG. No. FIG. No. BILD NR. FIG. n.
--	------------------------------------	--	--	--	---	---	---	--

6705/1	-	24	70	PK22S	1350	1000	10	45
6705/2	-	12	55	PK22S	1200	1000	10	45
6705/3	-	24	65	PK22S	1300	1000	10	45
6705/4	-	24	100	PK22S	2000	1000	10	45

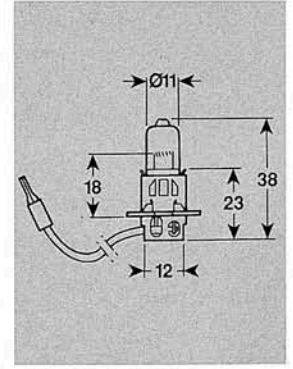
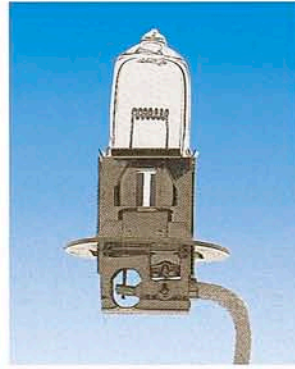
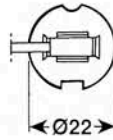

6709/1	H018366	22,8	75	R7S	1500	700	10	46
6709/2	10X58	6,6A.	100	R7S	2700	1000	10	46
6709/3	11X60	6,6A.	200	R7S	4200	1000	10	46

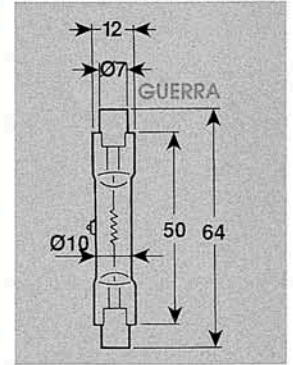
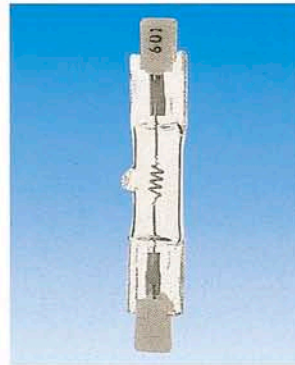

6801/0	-	24	40	E11	800	1000	10	47
6801/1	-	24	50	E11	900	1000	10	47
6801/2	-	24	60	E11	1200	1000	10	47

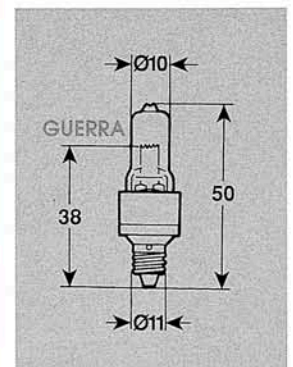

6801/3	-	24	60	E10	1200	1000	10	48
6801/4	-	24	100	E10	2200	1000	10	48

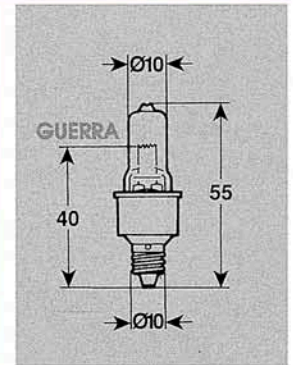
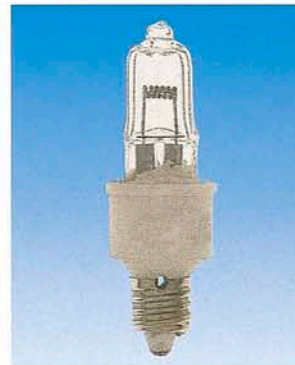

6901/1	HF28	24	150	BA20S	4500	300	10	49
6901/2	HF28	24	150	BA20S	3450	1000	10	49

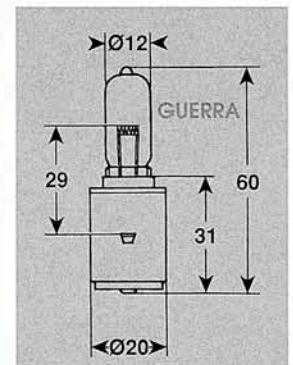

LAMPADE OTTICHE E A FESSURA. LAMPADE PER MICROSCOPI, COLPOSCOPI, MICROSCOPI OPERATORI; COLLIMATORI E ALTRI USI.



SLIT AND OPTICAL BULBS. BULBS FOR MICROSCOPES, COLPOSCOPES, OPERATING MICROSCOPES, COLLIMATORS AND OTHER USES.

LAMPES A FENTE ET OPTIQUES. LAMPES POUR MICROSCOPES, COLPOSCOPES, MICROSCOPES OPERATOIRES, COLLIMATEURS ET AUTRES USAGES.

OPTISCHE UND SCHLITZLAMPEN. MIKROSKOPIERLAMPEN LAMPEN FÜR KOLPOSKOPEN, OPERATIONS-MIKROSKOPE KOLLIMATOREN UND ANDEREN GEBRÄUCHE.

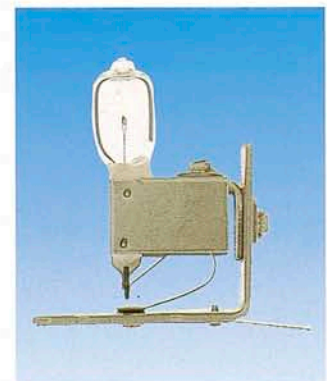
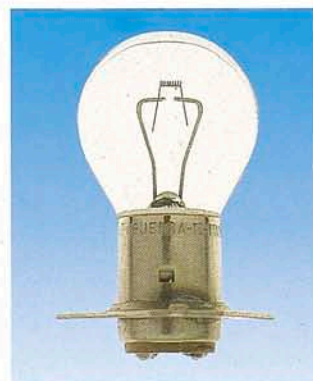

Q[®] **GUERRA**
www.lampsguerra.com

Q[®] **GUERRA**
www.lampsguerra.com

Q[®] **GUERRA**
www.lampsguerra.com

ART. No. ART. No. BEST. NR. CODICE	TYPE REF. TYP TIPO	VOLTAGE VOLTS VOLTS VOLT	WATTAGE WATTS WATTS WATT	BASE CULOT SOCKET BASE	LUMENS LUMENS LUMENS LUMEN.	LIFE DUREE LEBENSDAUER DURATA	QY/PACK PIECES/CARTON STK/KARTON IMB.	FIG. No. FIG. No. BILD NR. FIG. n.
--	------------------------------------	--	--	--	---	---	---	--

1168	GHAMBS	6	15	P45D	130	100	10	50
------	--------	---	----	------	-----	-----	----	----

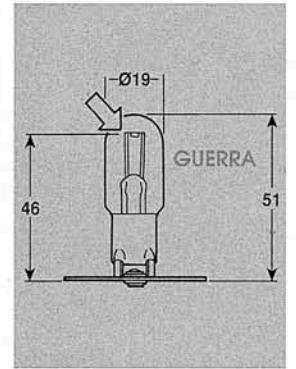
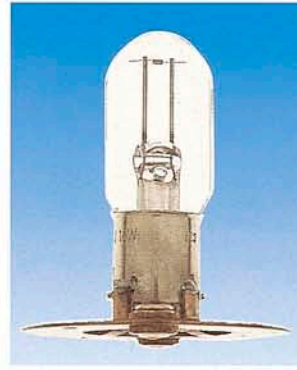
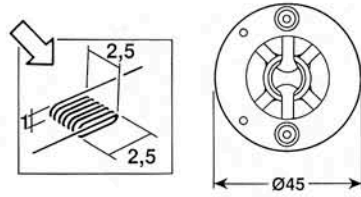

1465/2H		6	33	BA15D	430	80	10	51
1465/3		7	35	BA15D	460	100	10	51

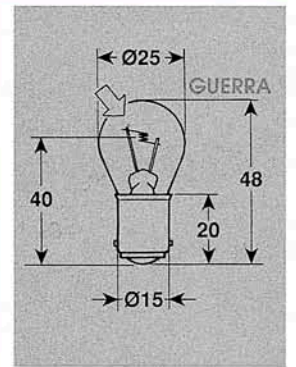
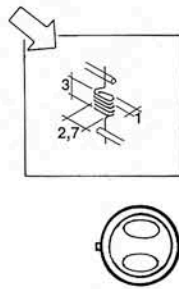

1565/1	-	6	15	BA15S	100	200	10	52
1565/2	-	6	25	BA15S	160	300	10	52

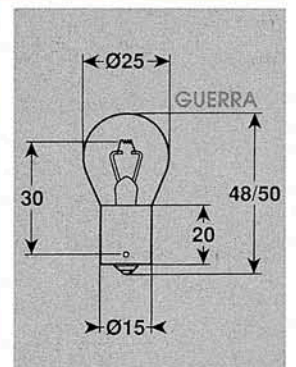

1566/2	-	6	25	BA15S	160	300	10	53
1566/4	1361	12	25	BA15S	400	600	10	53

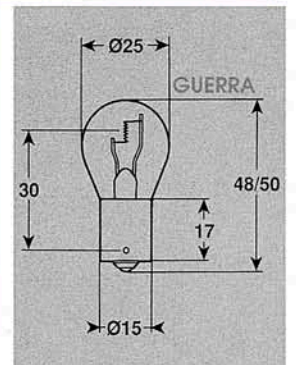

1762/AX	7582	12	25	P30S	400	600	10	54
---------	------	----	----	------	-----	-----	----	----

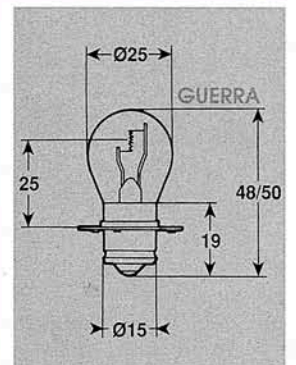
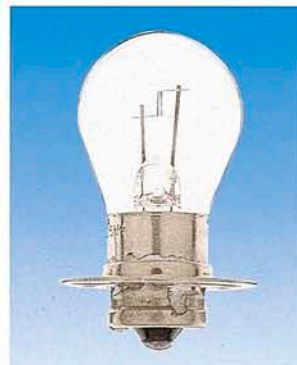
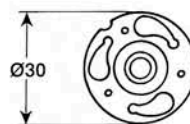

ART. No. ART. No. BEST. NR. CODICE	TYPE REF. TYP TIPO	VOLTAGE VOLTS VOLTS VOLT	WATTAGE WATTS WATTS WATT	BASE CULOT SOCKET BASE	LUMENS LUMENS LUMENS LUMEN.	LIFE DUREE LEBENSDAUER DURATA	QY/PACK PIECES/CARTON STK./KARTON IMB.	FIG. No. FIG. No. BILD NR. FIG. n.
---	-----------------------------	-----------------------------------	-----------------------------------	---------------------------------	--------------------------------------	--	---	---

1762/2	-	6	30	P30D	330	100	10	55
1762/H	-	7	35	P30D	460	100	10	55

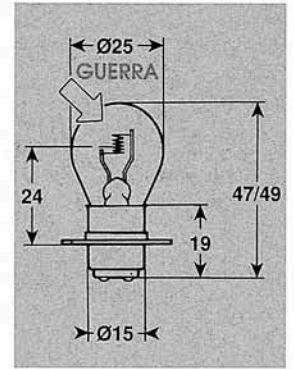
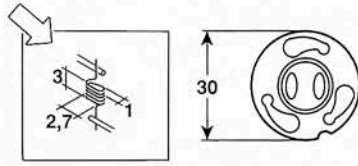

1762/3	GE.1630	6	15	P30D	130	100	10	56
--------	---------	---	----	------	-----	-----	----	----

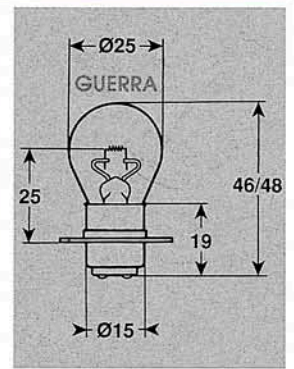
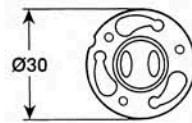

1762/4	GE.1520	6	15	P30D	130	100	10	57
1762/5	GE.1460X	6,5	2,75	P30D	200	100	10	57
1762/6	GE.1468X	6	4,5	P30D	300	80	10	57
1762/7	GE.1634	20	1A.	P30D	140	200	10	57

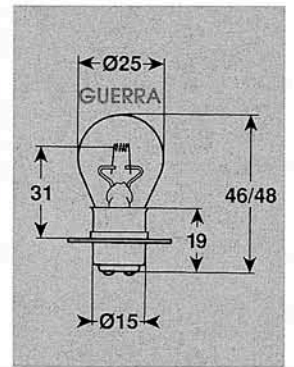
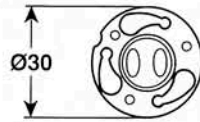

1763/1	5252012	12	25	P17S	370	300	10	58
1763/2	568302	24	25	P17S	400	300	10	58

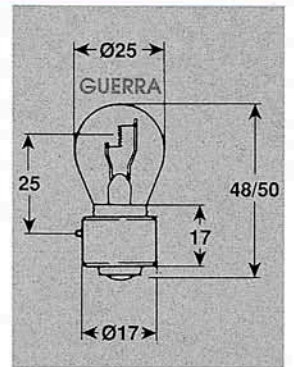

1861/1	H.8001	6	4,5A.	E14/16	360	100	10	59
1861/3	-	6	50	E14/16	500	120	10	59

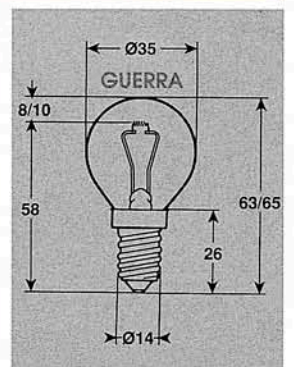

ART. No. ART. No. BEST. NR. CODICE	TYPE REF. TYP TIPO	VOLTAGE VOLTS VOLTS VOLT	WATTAGE WATTS WATTS WATT	BASE CULOT SOCKET BASE	LUMENS LUMENS LUMENS LUMEN.	LIFE DUREE LEBENSDAUER DURATA	QY/PACK PIECES/CARTON STK./KARTON IMB.	FIG. No. FIG. No. BILD NR. FIG. n.
---	-----------------------------	-----------------------------------	-----------------------------------	---------------------------------	--------------------------------------	--	---	---

1960/1	HS940-750	6	4,5A	P40S	360	100	10	60
--------	-----------	---	------	------	-----	-----	----	----

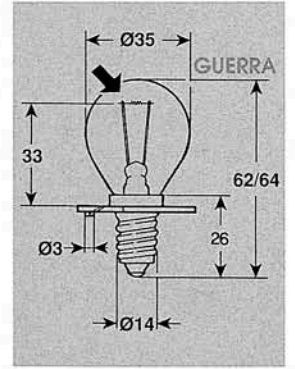
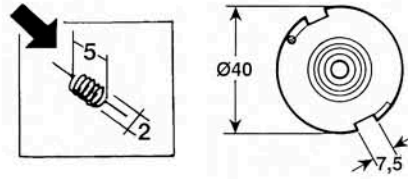

2058/3	RX	24	50	BA20D	600	500	10	61
--------	----	----	----	-------	-----	-----	----	----

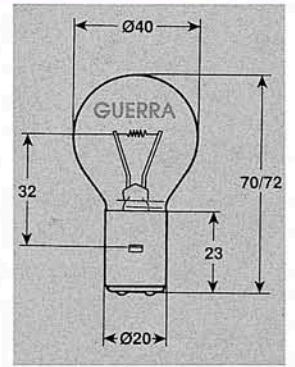

2158/1	HS900/930	6	4,5A.	P44S	360	100	10	62
2158/2	SPEC.	9	4,5A.	P44S	420	100	10	62

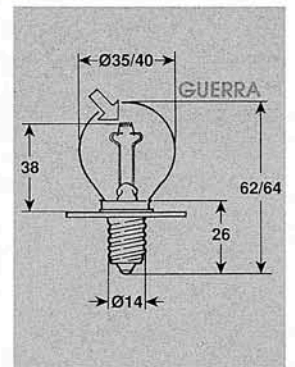
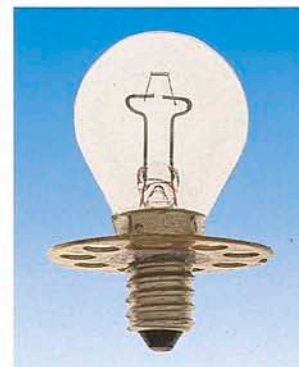
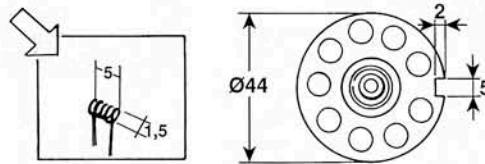

2158/3	HS900/930	6	4,5A.	P44S	360	100	10	63
--------	-----------	---	-------	------	-----	-----	----	----

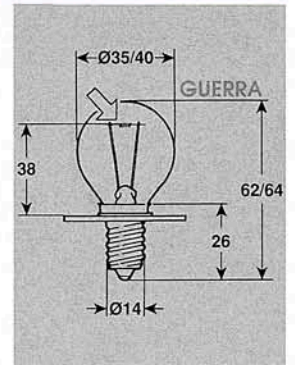
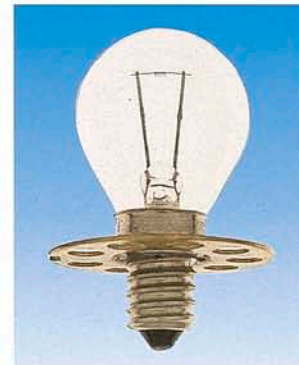
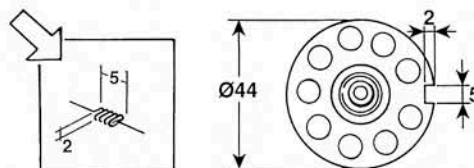

2158/H	HLX	12	50	P44S	1400	50	10	64
--------	-----	----	----	------	------	----	----	----

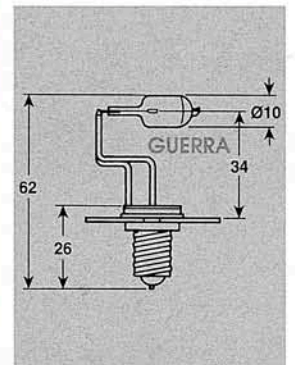
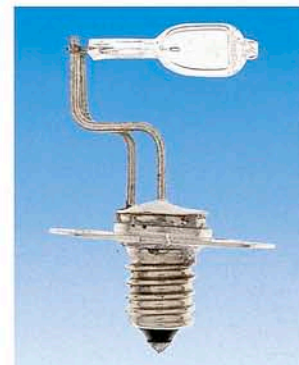
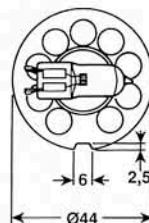

SPEC. = SPECIALE/SPECIAL/SONDER
 H. = ALOGENA/HALOGEN/HALOGENE

ART. No. ART. No. BEST. NR. CODICE	TYPE REF. TYP TIPO	VOLTAGE VOLTS VOLTS VOLT	WATTAGE WATTS WATTS WATT	BASE CULOT SOCKET BASE	LUMENS LUMENS LUMENS LUMEN.	LIFE DUREE LEBENSDAUER DURATA	QY/PACK PIECES/CARTON STK./KARTON IMB.	FIG. No. FIG. No. BILD NR. FIG. n.
--	------------------------------------	--	--	--	---	---	--	--

2756/1	S.4179	6	30	P27D	430	100	10	65
--------	--------	---	----	------	-----	-----	----	----

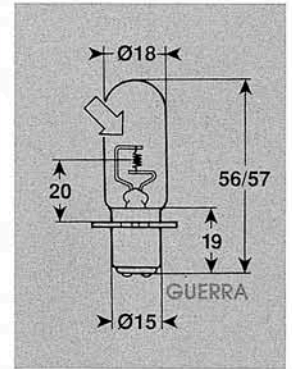
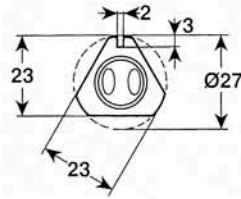
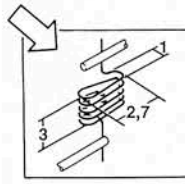

2756/464	70464	12	25	P255	360	100	10	66
2756/506	70506	6	15	P255	180	100	10	66

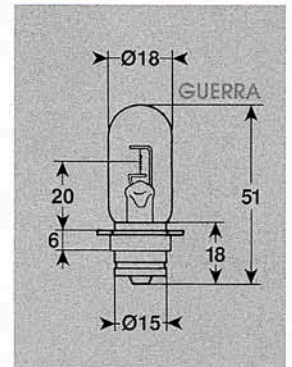
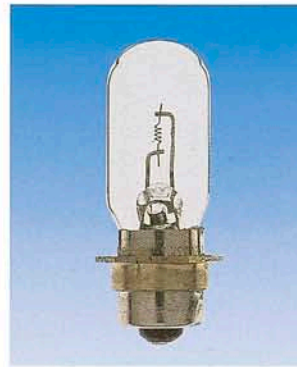
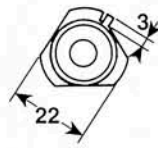

2756/H	-	6	33	P28S	430	80	10	67
--------	---	---	----	------	-----	----	----	----

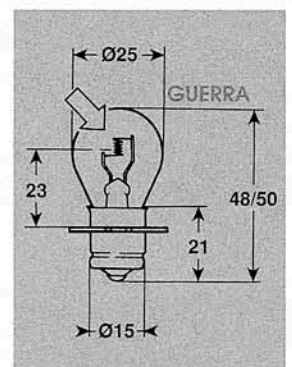
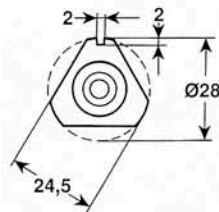
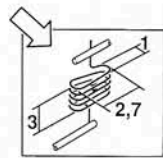

2756/NK	-	6	15	P25D	180	100	10	68
---------	---	---	----	------	-----	-----	----	----

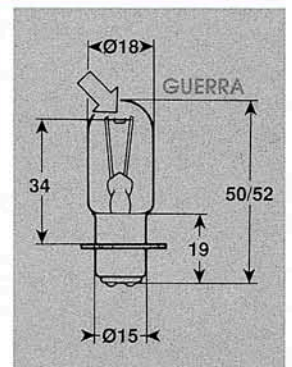
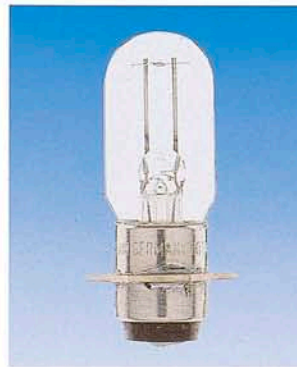
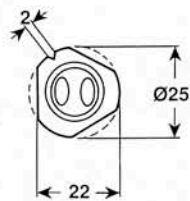

2756/R	70505	6	15	SPEC.	130	1000	10	69
--------	-------	---	----	-------	-----	------	----	----

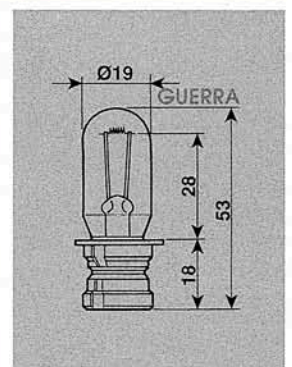
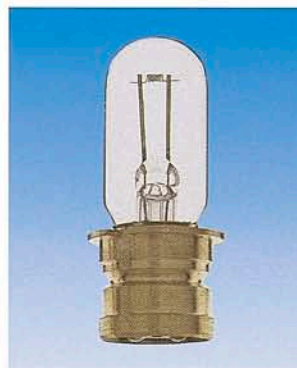
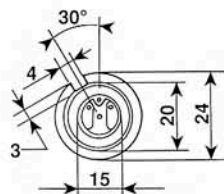

ART. No. ART. No. BEST. NR. CODICE	TYPE REF. TYP TIPO	VOLTAGE VOLTS VOLTS VOLT	WATTAGE WATTS WATTS WATT	BASE CULOT SOCKET BASE	LUMENS LUMENS LUMENS LUMEN.	LIFE DUREE LEBENSDAUER DURATA	QY/PACK PIECES/CARTON STK./KARTON IMB.	FIG. No. FIG. No. BILD NR. FIG. n.
2855	1730	6	15	P22D	180	100	10	70

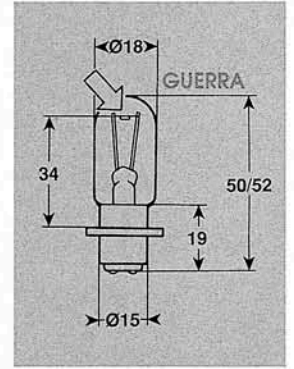
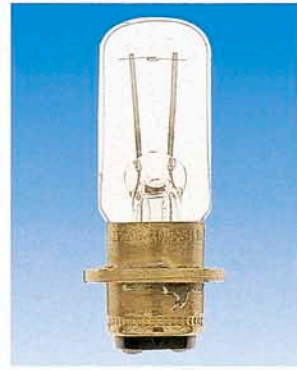
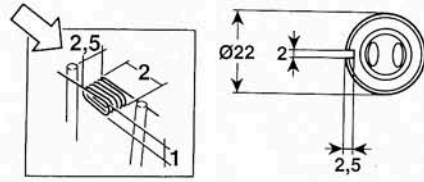

2954	1740	6	15	P25D/4	180	100	10	71
------	------	---	----	--------	-----	-----	----	----

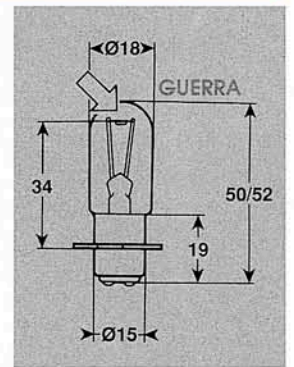
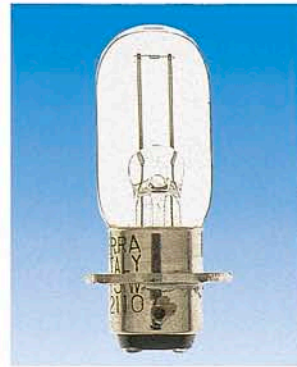
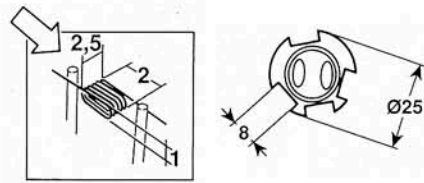

3053	OP150	6	30	P35,5D	400	200	10	72
------	-------	---	----	--------	-----	-----	----	----

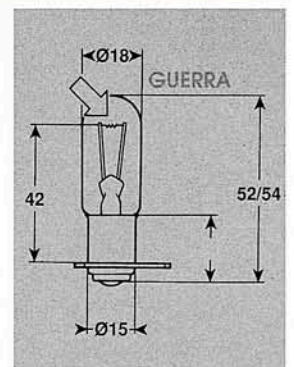
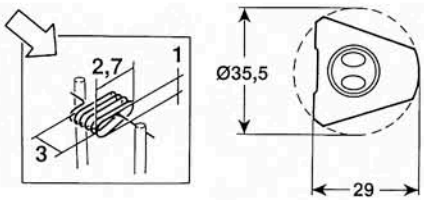

3251	177160W	6	20	P21D	200	100	10	73
------	---------	---	----	------	-----	-----	----	----

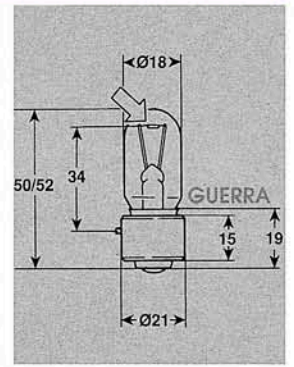
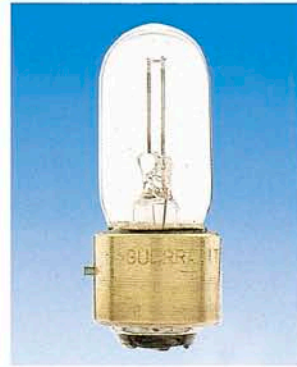
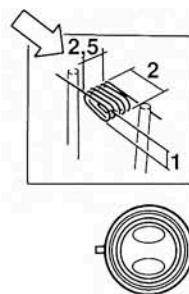

3350/1	67273	6	15	MB16	180	100	10	74
3350/C	-	6	15	MB16	180	100	10	74

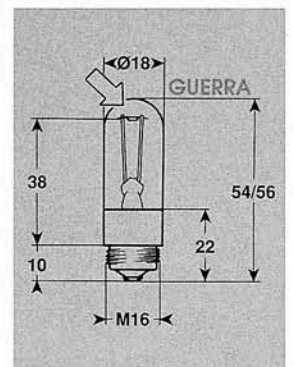
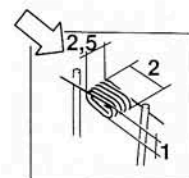

ART. No. ART. No. BEST. NR. CODICE	TYPE REF. TYP TIPO	VOLTAGE VOLTS VOLTS VOLT	WATTAGE WATTS WATTS WATT	BASE CULOT SOCKET BASE	LUMENS LUMENS LUMENS LUMEN.	LIFE DUREE LEBENSDAUER DURATA	QY/PACK PIECES/CARTON STK./KARTON IMB.	FIG. No. FIG. No. BILD NR. FIG. n.
3351/1	67251	6	15	MB16	180	80	10	75
3351/2	67471	6	30	MB16	575	50	10	75

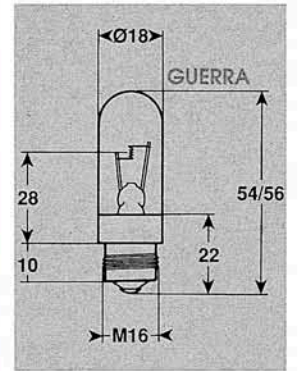

3430/1	13347	6	15	BA15D	180	100	10	76
3430/2	-	6	30	BA15D	400	100	10	76

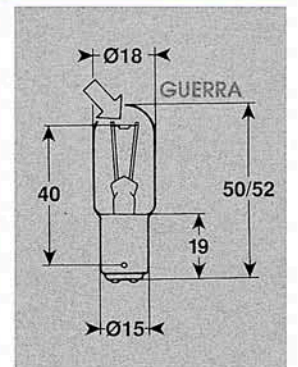
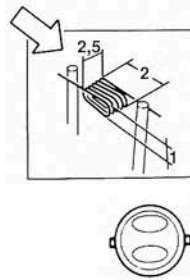

3440	-	6	33	P34D	450	80	-	77
------	---	---	----	------	-----	----	---	----

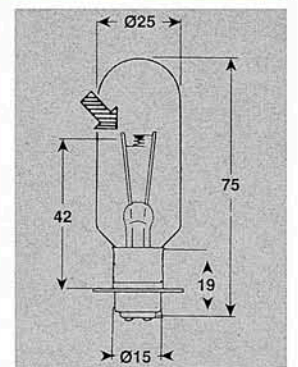
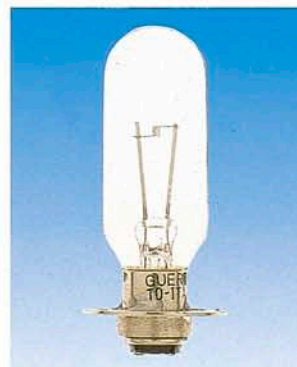
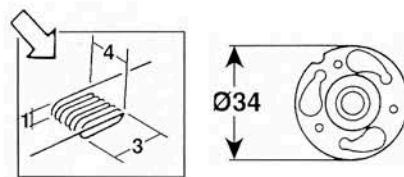

HLX4643	-	12	50	SPEC.	1400	50	3	78
HLX3719	-	12	30	SPEC.	750	50	3	78

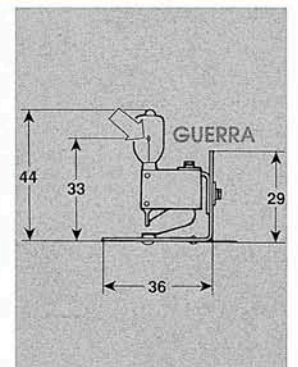
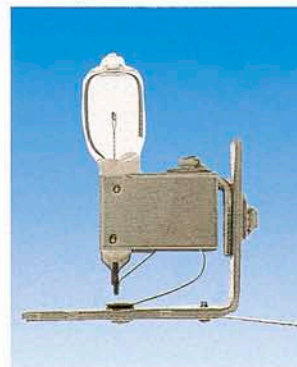
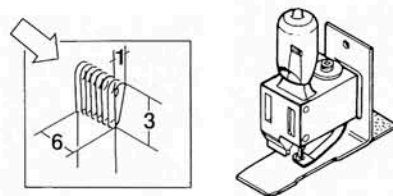

3441	-	12	50	P30S	950	2000	10	79
------	---	----	----	------	-----	------	----	----

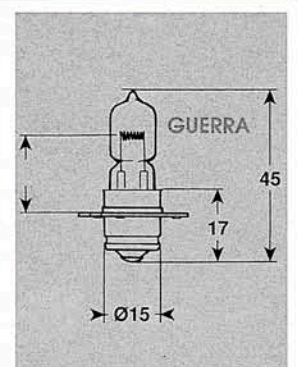
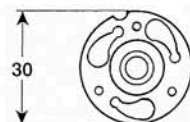

ART. No. BEST. NR. CODICE	TYPE REF. TYP TIPO	VOLTAGE VOLTS VOLTS VOLT	WATTAGE WATTS WATTS WATT	BASE CULOT SOCKET BASE	LUMENS LUMENS LUMENS LUMEN.	LIFE DUREE LEBENSDAUER DURATA	QV/PACK PIECES/CARTON STK/KARTON IMB.	FIG. No. FIG. No. BILD NR. FIG. n.
---------------------------------	-----------------------------	-----------------------------------	-----------------------------------	---------------------------------	--------------------------------------	--	--	---

3548/Z	39-01-86	6	50	P47D	500	120	10	80
3746/Z	39-01-58	6	30	P47D	400	100	10	80
3746/P	P	12	60	P47D	1200	80	10	80
3746/M	M	12	35	P47D	500	100	10	80

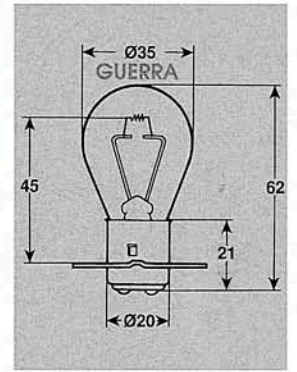
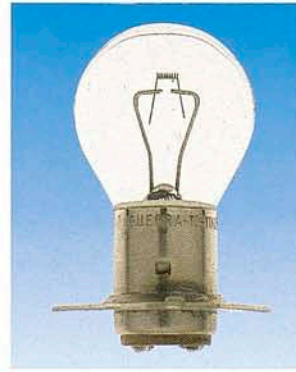
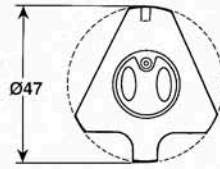

3647/L	39-01-53	6	25	P47D	300	100	10	81
--------	----------	---	----	------	-----	-----	----	----

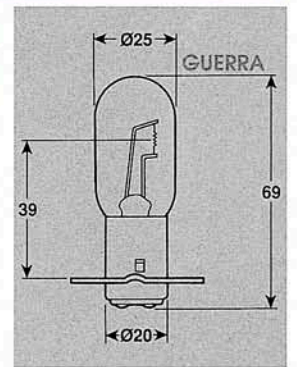
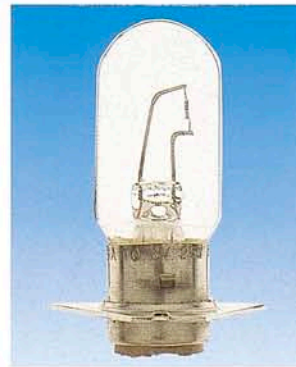
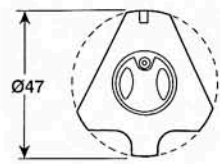

3748/B	-	6	30	SPEC.	400	100	10	82
--------	---	---	----	-------	-----	-----	----	----

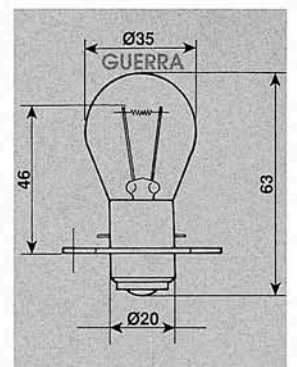
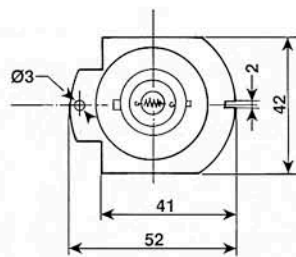

3749/1	NA.	6	30	BA20D	400	100	10	83
3749/2	8022	6	50	BA20D	500	120	10	83
3749/OB	BLACK	6	30	BA20D	400	100	10	83

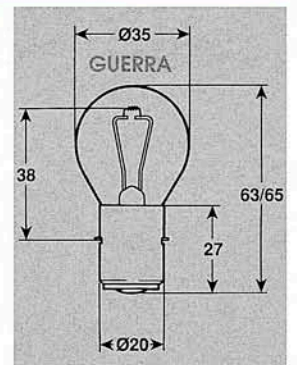
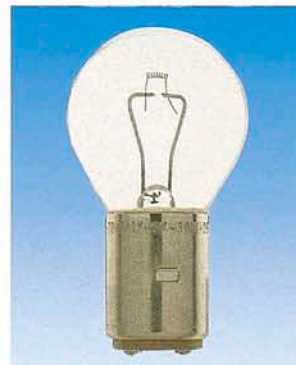

3750/1	HS600	11	50	SPEC.	450	500	10	84
--------	-------	----	----	-------	-----	-----	----	----

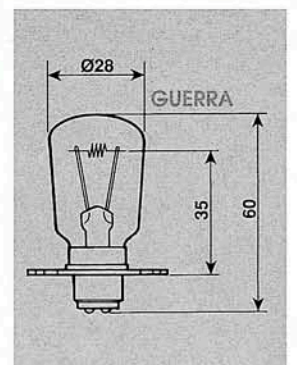
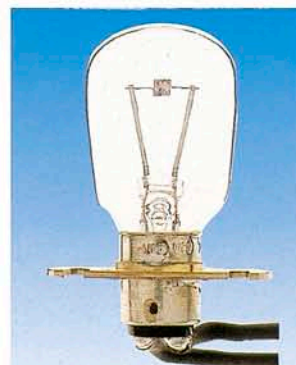
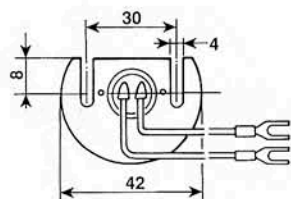

OB = NERO/BLACK/NOIR/SCHWARZ
 SPEC. = SPECIALE/SPECIAL/SONDER

ART. No. ART. No. BEST. NR. CODICE	TYPE REF. TYP TIPO	VOLTAGE VOLTS VOLTS VOLT	WATTAGE WATTS WATTS WATT	BASE CULOT SOCKET BASE	LUMENS LUMENS LUMENS LUMEN.	LIFE DUREE LEBENSDAUER DURATA	QY/PACK PIECES/CARTON STK./KARTON IMB.	FIG. No. FIG. No. BILD NR. FIG. n.
---	-----------------------------	-----------------------------------	-----------------------------------	---------------------------------	--------------------------------------	--	---	---

3770/3	2520	12	60	BA20D	1400	100	10	85
3770/4	-	12	100	BA20D	1900	100	10	85

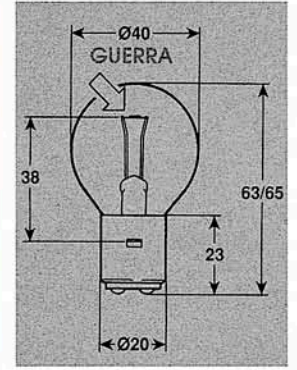
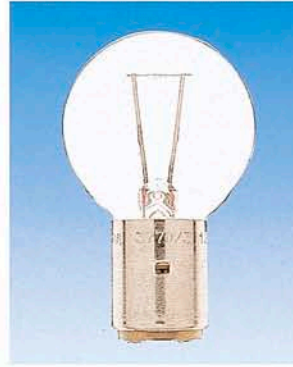
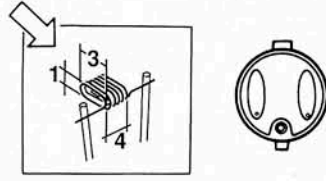

3880/1	-	6	30	BA20D	330	100	10	86
3880/2	-	6	50	BA20D	420	100	10	86
3880/3	-	12	50	BA20D	1200	200	10	86
3880/4	8029	15	60	BA20D	1500	100	10	86

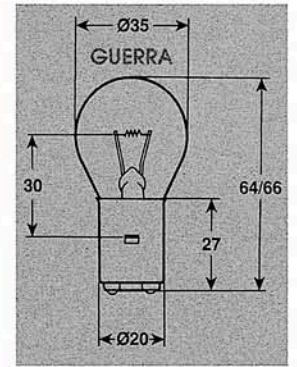

3890	-	6	30	BA15D	400	100	10	87
------	---	---	----	-------	-----	-----	----	----

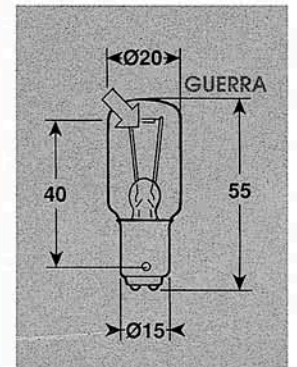
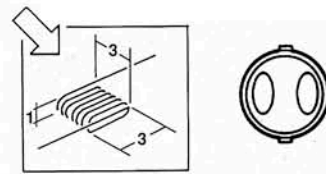

3890/1	ML515	6	15	SPEC.	180	100	-	88
3890/2	ML530	6	30	SPEC.	130	100	-	88

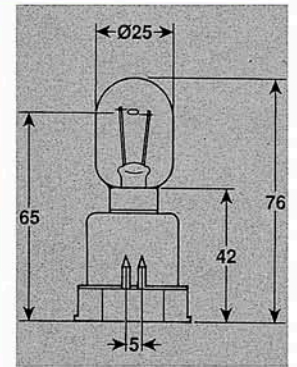
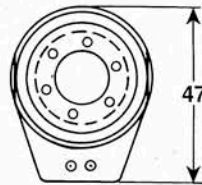

3892/2	-	6	30	BA15D	400	100	10	89
3892/3	-	6	33	BA15D	450	80	10	89

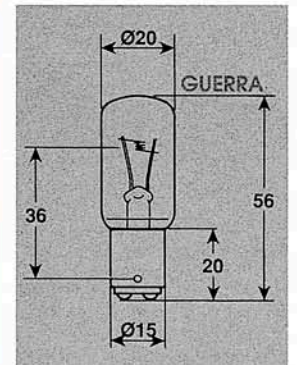
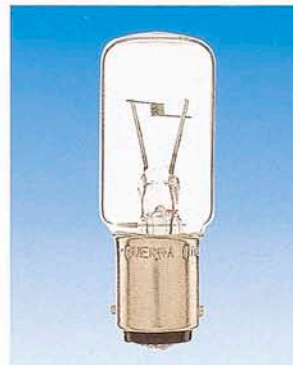

ART. No. ART. No. BEST. NR. CODICE	TYPE REF. TYP TIPO	VOLTAGE VOLTS VOLTS VOLT	WATTAGE WATTS WATTS WATT	BASE CULOT SOCKET BASE	LUMENS LUMENS LUMENS LUMEN.	LIFE DUREE LEBENSDAUER DURATA	QY/PACK PIECES/CARTON STK/KARTON IMB.	FIG. No. FIG. No. BILD NR. FIG. n.
3893/1	-	6	15	BA15D	180	100	10	90
3893/2	-	6	18	BA15D	220	100	10	90
3893/3	-	9	18	BA15D	240	100	10	90
3893/4	-	9	20	BA15D	250	100	10	90

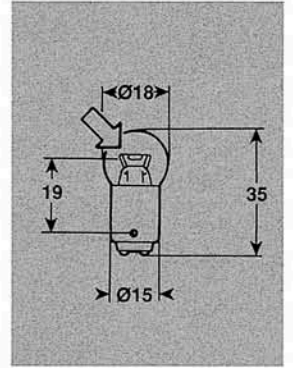
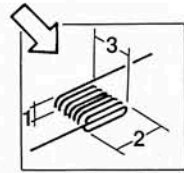

3893/NK	-	6	15	P25D	180	100	10	91
---------	---	---	----	------	-----	-----	----	----

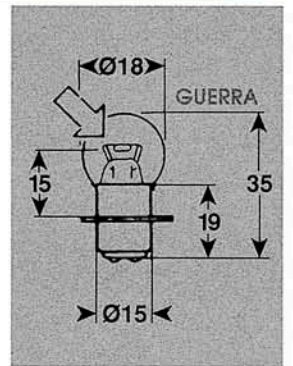
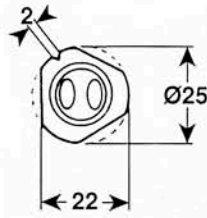
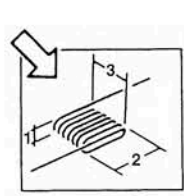

3893/H	-	6	20	P25D	480	100	10	92
--------	---	---	----	------	-----	-----	----	----

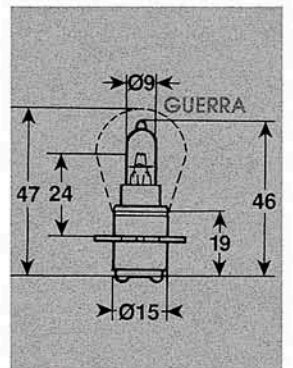
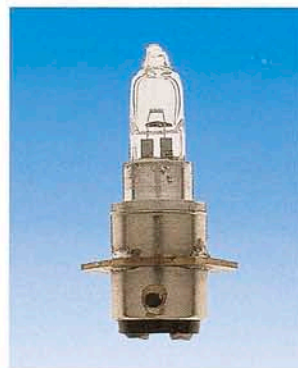
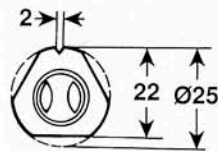

3894/1	-	9	18	BA15S	240	100	10	93
3894/2	-	6	15	BA15S	180	100	10	93

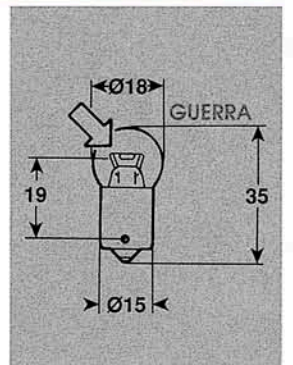
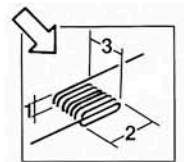

3895/1	-	9	18	P27S	240	100	10	94
--------	---	---	----	------	-----	-----	----	----

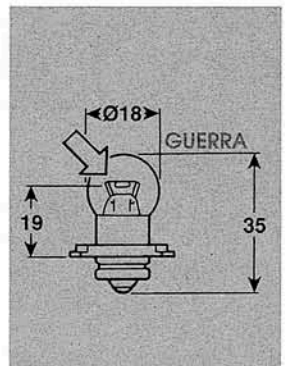
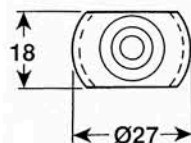
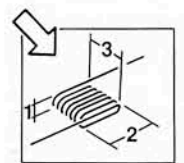

ART. No. ART. No. BEST. NR. CODICE	TYPE REF. TYP TIPO	VOLTAGE VOLTS VOLTS VOLT	WATTAGE WATTS WATTS WATT	BASE CULOT SOCKET BASE	LUMENS LUMENS LUMENS LUMEN.	LIFE DUREE LEBENSDAUER DURATA	QV/PACK PIECES/CARTON STK./KARTON IMB.	FIG. No. FIG. No. BILD NR. FIG. n.
--	------------------------------------	--	--	--	---	---	--	--

3896/SP	SP	12	40	BA15S	500	100	10	95
---------	----	----	----	-------	-----	-----	----	----

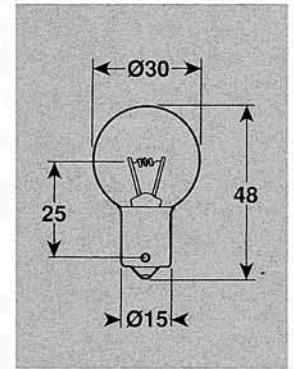

3897/0	SP	6	18	BA15D	320	100	10	96
3897/SP	SP	220	20	BA15D	140	300	10	96
3897/SM	SM	120	20	BA15D	160	200	10	96

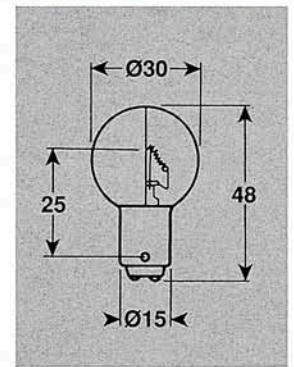

3897/CH	CH	220	30	BA15D	400	300	10	97
3897/1	CH	220	20	BA15D	140	400	10	97
3897/2	CH	120	30	BA15D	400	300	10	97
3897/3	CH	120	20	BA15D	140	400	10	97
3897/4	CH	6	18	BA15D	320	100	10	97

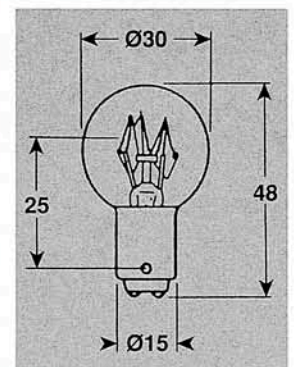

3898/CH	CH	220	15	E16	120	300	10	98
3898/SM	SM	220	15	E16	100	300	10	98
3898/CH	CH	220	20	E16	140	300	10	98
3898/SM	SM	220	20	E16	130	300	10	98

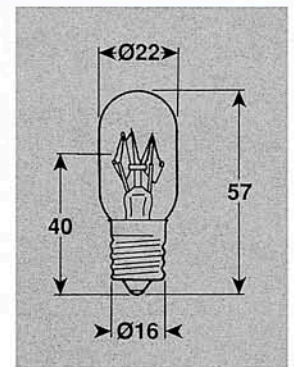
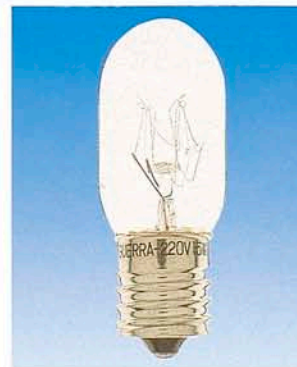

3899/SM	SM	220	15	E16	120	300	10	99
3899/1	SM	120	15	E16	110	300	10	99

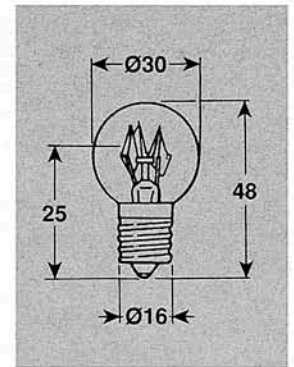

SP = SPECCHIATA LATERALE/SIDE MIRRORING/MIROIR LATERAL/SEITLICH GESPIEGELT
CH = CHIARA/CLEAR/CLAIRE/KLAR
SM = SATINATA/FROSTED/MAT/MATTIERT

ART. No. ART. No. BEST. NR. CODICE	TYPE REF. TYP TIPO	VOLTAGE VOLTS VOLTS VOLT	WATTAGE WATTS WATTS WATT	BASE CULOT SOCKET BASE	LUMENS LUMENS LUMENS LUMEN.	LIFE DUREE LEBENSDAUER DURATA	QY/PACK PIECES/CARTON STK/KARTON IMB.	FIG. No. FIG. No. BILD NR. FIG. n.
---	-----------------------------	-----------------------------------	-----------------------------------	---------------------------------	--------------------------------------	--	--	---

3900/CH	CH	220	15	E27	130	500	10	100
3900/SM	SM	220	15	E27	120	400	10	100
3901/CH	CH	220	25	E27	200	500	10	100
3901/SM	SM	220	25	E27	180	400	10	100
3902	CH	120	15	E27	100	600	10	100
3903	CH	120	20	E27	150	500	10	100
3904	CH	120	30	E27	320	300	10	100

3905/SM	SM	220	15	E27	120	500	10	101
3906/SM	SM	120	15	E27	100	500	10	101

4637/SP	SP	220	20	BA15D	180	200	10	102
4637/SP	SP	220	30	BA15D	200	200	10	102
4638	SP	120	20	BA15D	200	200	10	102
4639	SP	120	30	BA15D	300	200	10	102



4840/NK	SP	220	30	BA15D	180	200	10	103
4841/NK	SP	220	20	BA15D	150	300	10	103
4842	SP	120	30	BA15D	180	200	10	103
4843	SP	120	20	BA15D	150	300	10	103

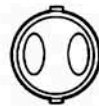

4844/1	CH	220	15	BA15D	120	500	10	104
4844/2	CH	220	20	BA15D	150	500	10	104
4844/3	CH	120	20	BA15D	150	500	10	104



SP = SPECCHIATA LATERALE/SIDE MIRRORED/MIROIR LATERAL/SEITLICH GESPIEGELT
 CH = CHIARA/CLEAR/CLAIRE/KLAR
 SM = SATINATA/FROSTED/MAT/MATTIERT

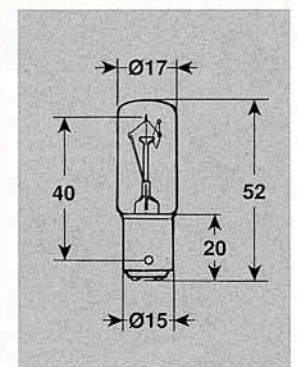
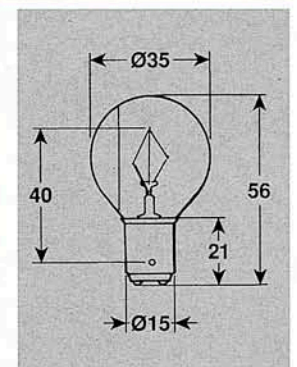
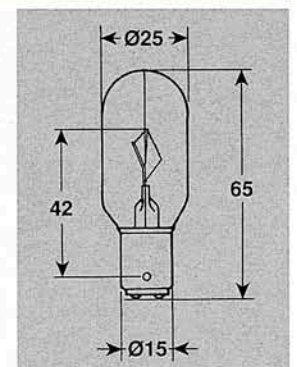
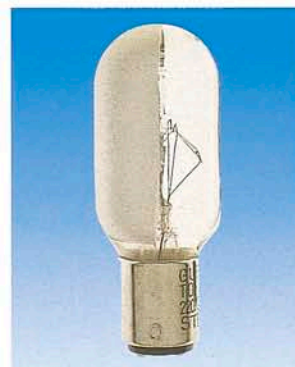
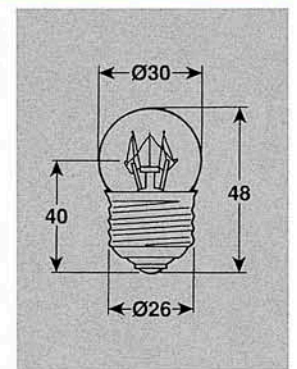
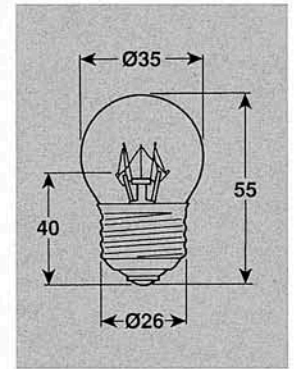
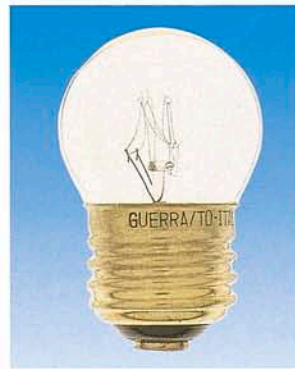

Q[®] **GUERRA**
www.lampsguerra.com

Q[®] **GUERRA**
www.lampsguerra.com

Q[®] **GUERRA**
www.lampsguerra.com

**LAMPADE PER ENDOSCOPIA, OTTICA, MICROSCOPIA,
FONTI LUMINOSE, ANALIZZATORI, OFTALMOSCOPIA ED ALTRI USI.**



OPTICAL AND OPHTHALMIC BULBS. BULBS FOR ENDOSCOPY, MICROSCOPY,
LIGHT SOURCES, ANALYZERS AND OTHER USES.

LAMPES OPTIQUES ET OPHTHALMIQUES. LAMPES POUR ENDOSCOPIE,
MICROSCOPIE, SOURCES LUMINEUSES, ANALYSEURS ET AUTRES USAGES.

OPTISCHE UND OPHTHALMISCHE LAMPEN. LAMPEN FÜR ENDOSKOPIE, MIKROSKOPIE,
LICHTSQUELLEN, ANALYSATOREN, OPHTHALMOSKOPIE UND ANDEREN GEBRÄUCHE.

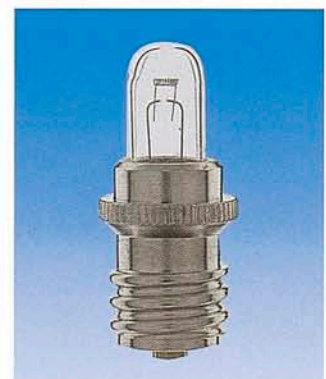
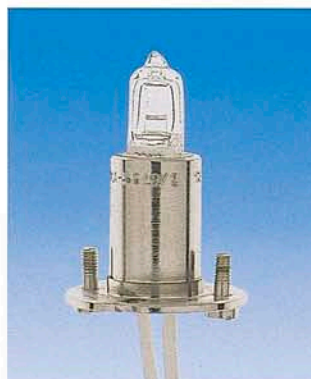
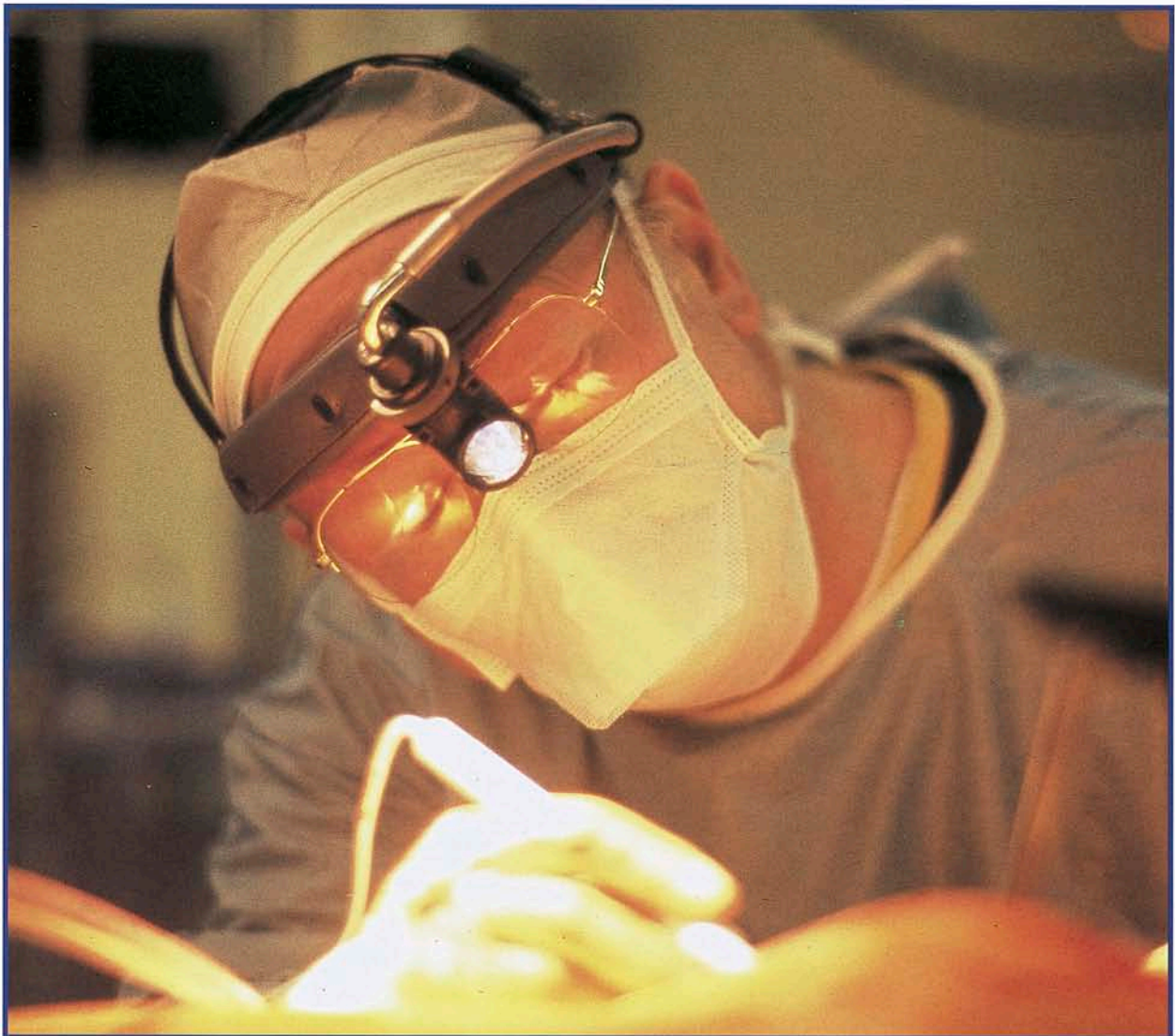

Q[®] GUERRA
www.lampsguerra.com

Q[®] GUERRA
www.lampsguerra.com

Q[®] GUERRA
www.lampsguerra.com

ART. No. ART. No. BEST. NR. CODICE	TYPE REF. TYP TIPO	VOLTAGE VOLTS VOLTS VOLT	WATTAGE WATTS WATTS WATT	BASE CULOT SOCKET BASE	LUMENS LUMENS LUMENS LUMEN.	LIFE DUREE LEBENSDAUER DURATA	QY/PACK PIECES/CARTON STK/KARTON IMB.	FIG. No. FIG. No. BILD NR. FIG. n.
5132/6	SPEC.	6	30	GZ6,35	—	500	6	1
5132/1	EFM	8	50	GZ6,35	—	50	6	1
5132/2	EFN	12	75	GZ6,35	—	50	6	1
5132/3	EFP	12	100	GZ6,35	—	50	6	1
5132/4	EFR	15	150	GZ6,35	—	50	6	1

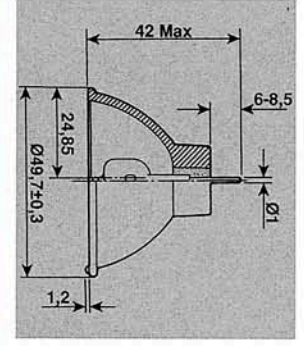
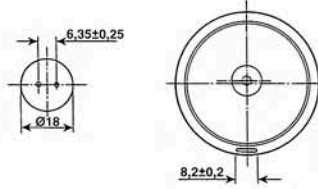

5132/5	EKZ	10,8	30	GX5,3	—	50	6	2
5132/6	EPZ	13,8	50	GX5,3	—	1000	6	2
5132/7	DDM	19	80	GX5,3	—	50	6	2
5132/8	DDL	20	150	GX5,3	—	500	6	2
5132/9	EJM	21	150	GX5,3	—	40	6	2
5132/10	ELD	21	150	GX5,3	—	40	6	2
5132/11	EJA	21	150	GX5,3	—	40	6	2
5132/12	EJL	24	200	GX5,3	—	25	6	2
5132/13	ELC	24	250	GX5,3	—	50	6	2
5132/14	ENX	82	350	GX5,3	—	75	6	2
5132/15	ELH	120	300	GX5,3	—	35	6	2
5132/16	EVW	82	250	GX5,3	—	50	6	2
5132/17	FHS	82	300	GX5,3	—	35	6	2
5132/18	EJV	21	150	GX5,3	—	40	6	2
5132/19	EPX	14,5	90	GX5,3	—	500	6	2

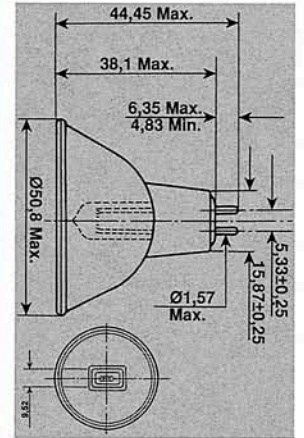

5330/1	DNF	21	150	GY7,9	—	25	6	3
5330/2	DNE	120	150	GY7,9	—	12	6	3

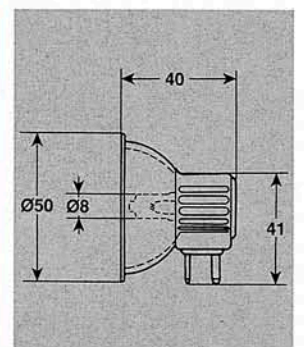

5331/1	64255	8	20	G.4	—	50	10	4
5331/2	64605	8	50	G.4	—	25	10	4
5331/3	64600	6	35	G.4	—	50	10	4

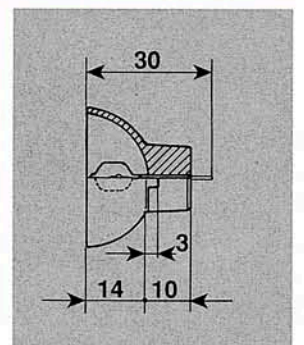
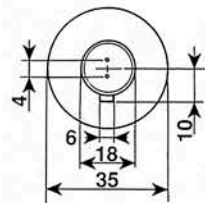

5332/1	64617	12	75	G.5,3	—	25	6	5
5332/2	64624	12	100	G.5,3	—	25	6	5

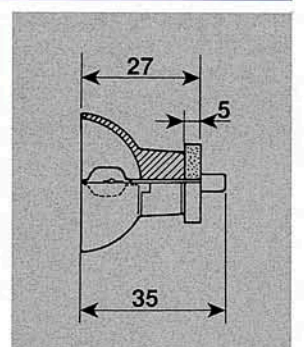
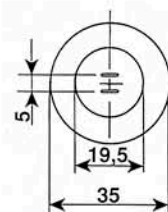

ART. No. ART. No. BEST. NR. CODICE	TYPE REF. TYP TIPO	VOLTAGE VOLTS VOLTS VOLT	WATTAGE WATTS WATTS WATT	BASE CULOT SOCKET BASE	LUMENS LUMENS LUMENS LUMEN.	LIFE DUREE LEBENSDAUER DURATA	QY/PACK PIECES/CARTON STK./KARTON IMB.	FIG. No. FIG. No. BILD NR. FIG. n.
55122	HLWSS	6	10	PY16-1,25	195	100	10	1
55125	HLWSS	6	10	PY16-1,25	150	100	10	1
55133	HLWSS	6	20	PY16-1,25	450	100	10	1
55147	HLWSS-A	6	25	PY16-1,25	510	100	10	1
55149	HLWSS	6	25	PY16-1,25	525	75	10	1
55127	HLWSS	12	10	PY16-1,25	140	50	10	1
55140	HLWSS-A	12	20	PY16-1,25	350	1000	10	1

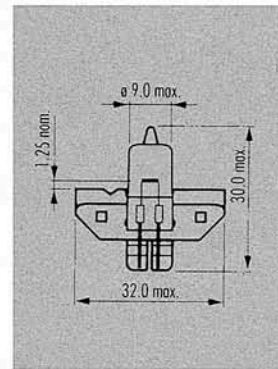
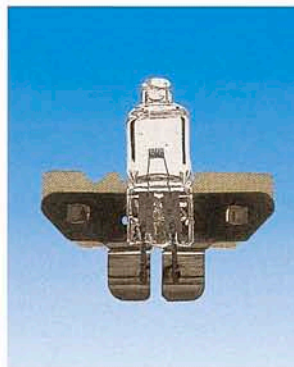

55204	HLWSS	12	50	PY24-1,5	1400	50	10	2
55205	HLWSS-A	12	50	PY24-1,5	1400	50	10	2
55305	HLWSS	12	100	PY24-1,5	3000	50	10	2
55307	HLWSS-A	12	100	PY24-1,5	3000	50	10	2

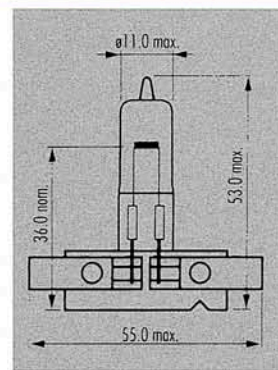
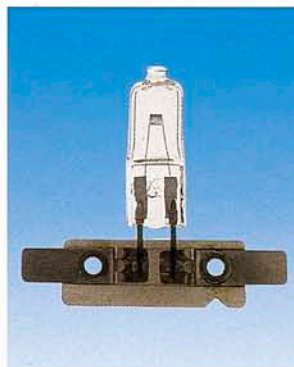

55405	HLWSS	24	150	PY24-1,5	5000	50	10	3
-------	-------	----	-----	----------	------	----	----	---

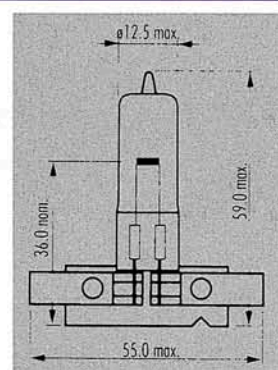
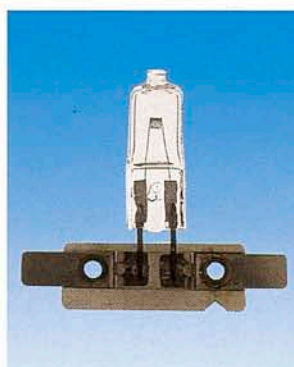

55503	HLWSS	24	250	PY24-1,5	8500	50	10	4
55507	HLWSS-A	24	250	PY24-1,5	8500	50	10	4

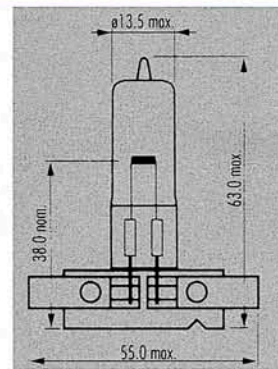
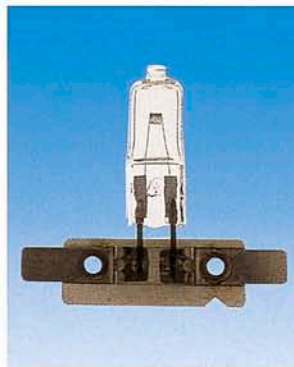

55606	HLWSS	36	400	PY24-1,5	14500	50	10	5
-------	-------	----	-----	----------	-------	----	----	---

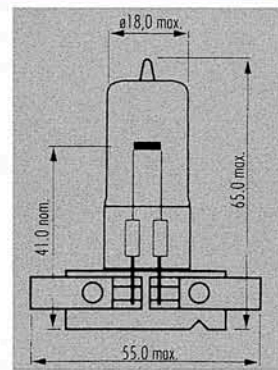
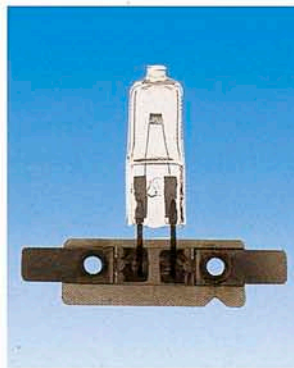

ART. No. ART. No. BEST. NR. CODICE	TYPE REF. TYP TIPO	VOLTAGE VOLTS VOLTS VOLT	WATTAGE WATTS WATTS WATT	BASE CUILOT SOCKET BASE	LUMENS LUMENS LUMENS LUMEN.	LIFE DUREE LEBENSDAUER DURATA	QY/PACK PIECES/CARTON STK/KARTON IMB.	FIG. No. FIG. No. BILD NR. FIG. n.
5628/W0	64251	6	20	PG22	500	100	10	1
5628/W1	64222	6	10	PG22	150	300	10	1
5628/W2	64260	12	30	PG22	800	50	10	1
5628/1	64609	12	50	PG22	1500	50	10	1
5628/2	64626	12	100	PG22	3000	50	10	1

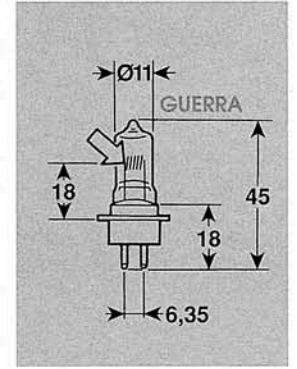
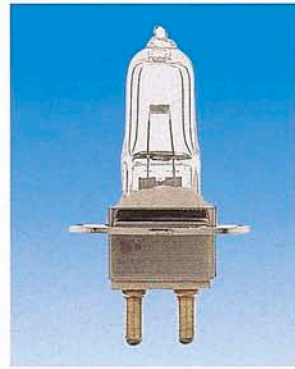
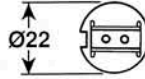
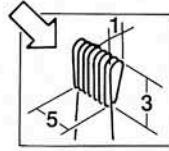

5825/1	DYR	220	650	GY9,5	16500	50	10	2
5825/2	DYP	120	600	GY9,5	17000	75	10	2

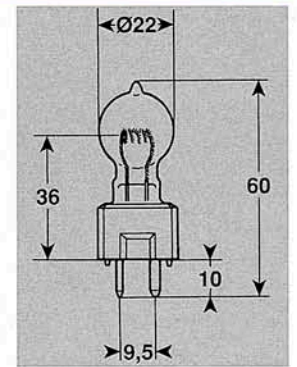
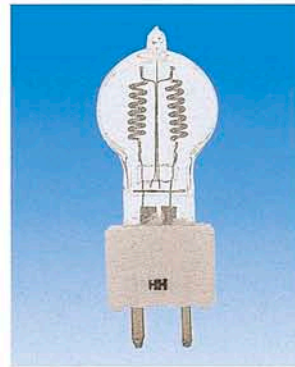

5924/0	-	12	30	G.6,35	750	50	10	3
5924/1	BRL	12	50	G.6,35	1400	50	10	3
5924/2	FCR	12	100	G.6,35	3000	50	10	3
5924/3	BRJ	15	150	G.6,35	5000	50	10	3
5924/4	FCS	24	150	G.6,35	5000	50	10	3

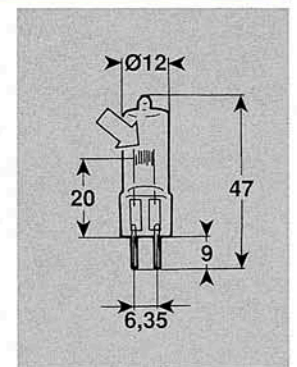
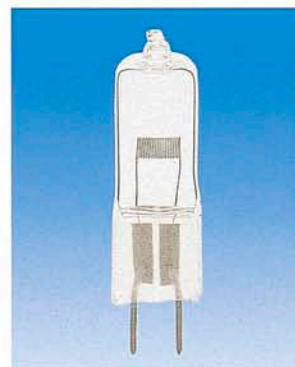
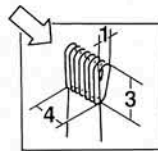

5924/5	EHJ	24	250	G.6,35	9500	50	10	4
5924/6	EVD	36	400	G.6,35	14500	50	10	4
5924/9	FNT	24	275	G.6,35	9500	75	10	4
5924/10	FLW	24	300	G.6,35	10200	50	10	4

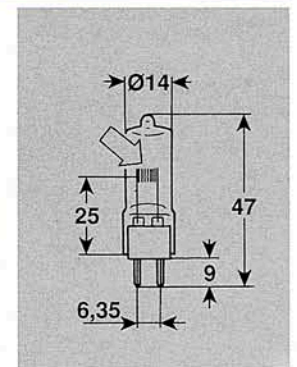
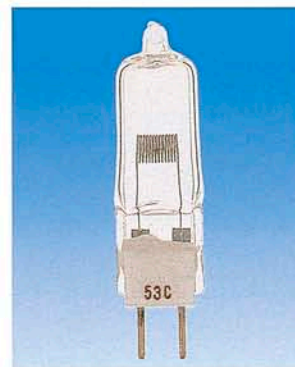
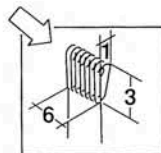

6320/1	S.4140	6	20	G.4	420	100	10	5
--------	--------	---	----	-----	-----	-----	----	---

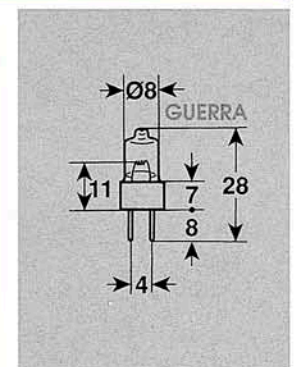
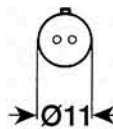

ART. No. ART. No. BEST. NR. CODICE	TYPE REF. TYP TIPO	VOLTAGE VOLTS VOLTS VOLT	WATTAGE WATTS WATTS WATT	BASE CULOT SOCKET BASE	LUMENS LUMENS LUMENS LUMEN.	LIFE DUREE LEBENSDAUER DURATA	QY/PACK PIECES/CARTON STK/KARTON IMB.	FIG. No. FIG. No. BILD NR. FIG. n.
---	-----------------------------	-----------------------------------	-----------------------------------	---------------------------------	--------------------------------------	--	--	---

5629/1	29-100	12	20	P26	350	2000	10	1
--------	--------	----	----	-----	-----	------	----	---

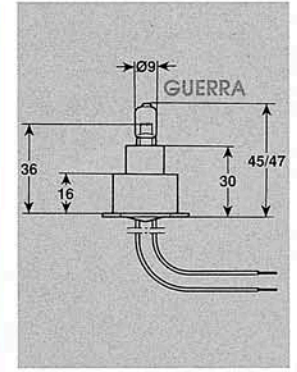
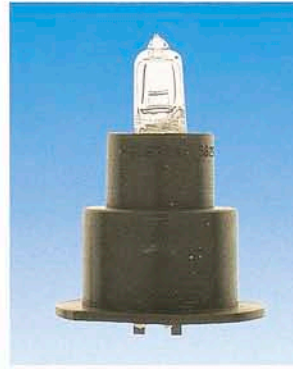
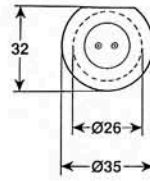

5629/2	705-0840	12	20	P15	350	2000	10	2
--------	----------	----	----	-----	-----	------	----	---

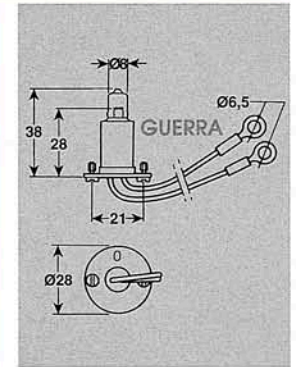
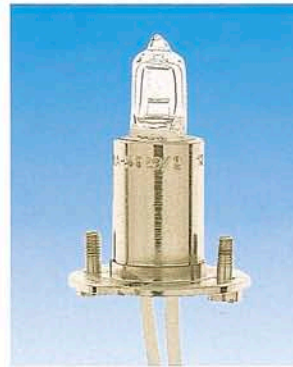

5629/3	-	6	10	SPEC.	200	1000	10	3
--------	---	---	----	-------	-----	------	----	---

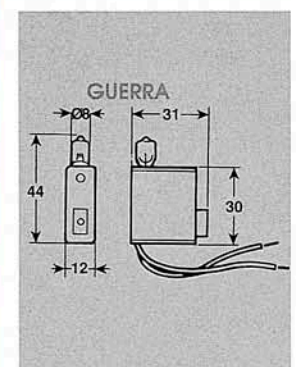

5629/4	AMES	6	10	SPEC.	200	1000	10	4
--------	------	---	----	-------	-----	------	----	---

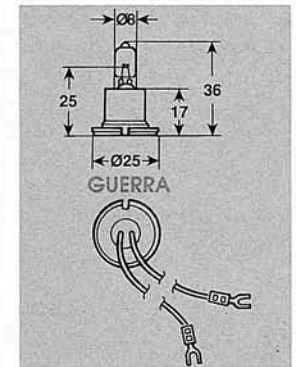
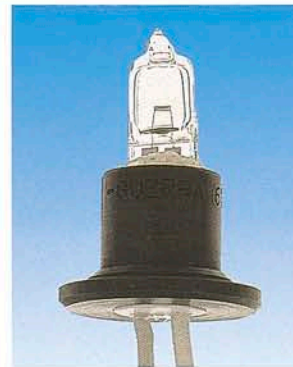

5629/5	-	6	10	SPEC.	200	1000	10	5
--------	---	---	----	-------	-----	------	----	---

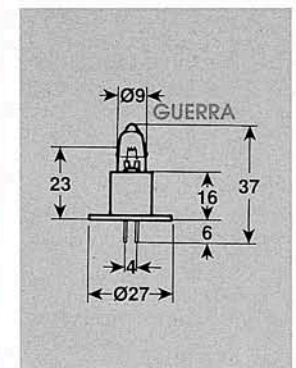
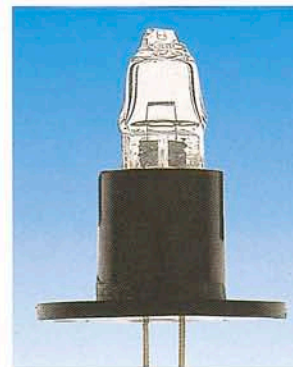

ART. No. ART. No. BEST. NR. CODICE	TYPE REF. TYP TIPO	VOLTAGE VOLTS VOLTS VOLT	WATTAGE WATTS WATTS WATT	BASE CULOT SOCKET BASE	LUMENS LUMENS LUMENS LUMEN.	LIFE DUREE LEBENSDAUER DURATA	QY/PACK PIECES/CARTON STK/KARTON IMB.	FIG. No. FIG. No. BILD NR. FIG. n.
6518/0	—	6	10	G.4	140	1000	10	6
6518/1	FHD	6	10	G.4	200	100	10	6
6518/2	ESB	6	20	G.4	450	100	10	6
6518/3	—	12	20	G.4	360	2000	10	6
6518/4	—	24	20	G.4	350	2000	10	6



GUERRA

PRODUZIONE LAMPADE SPECIALI
PRODUCTION OF SPECIAL LAMPS
PRODUCTION D'AMPOULES SPECIALES
HERSTELLUNG VON SONDERLAMPEN

6519/1	—	6	10	G.4	150	200	10	7
--------	---	---	----	-----	-----	-----	----	---

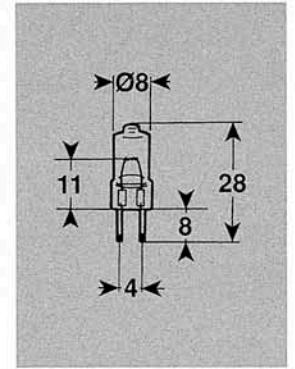

6520/3	—	12	30	G.6,35	750	1000	10	8
--------	---	----	----	--------	-----	------	----	---

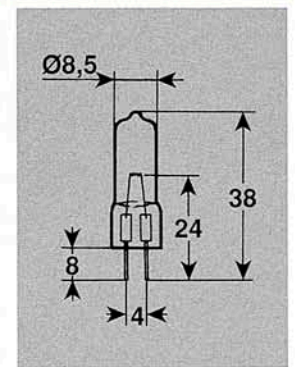

6521/1	HLL3	12	50	GY6,35-15	900	2000	10	9
6521/2	HLL	12	50	G6,35-15	1000	2000	10	9
6521/3	HLWS7	12	100	GY6,35-15	2550	2000	10	9

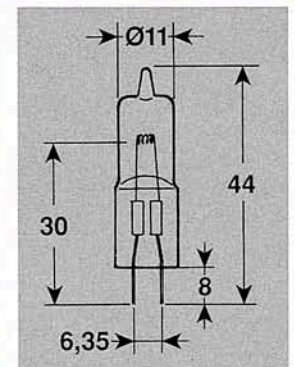
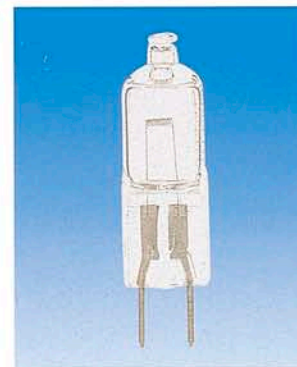

6522/1	HLL	24	20	G4	320	1000	10	10
6522/2	HLL	12	20	G4	360	2000	10	10

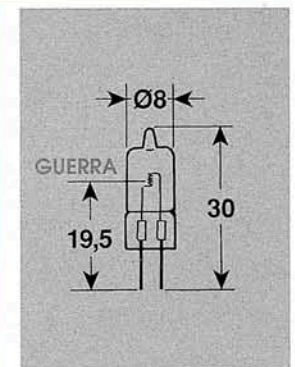
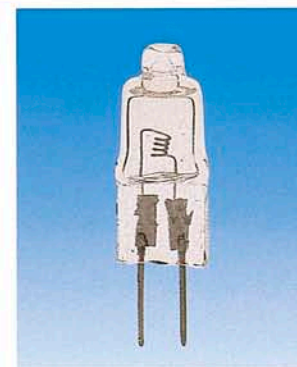
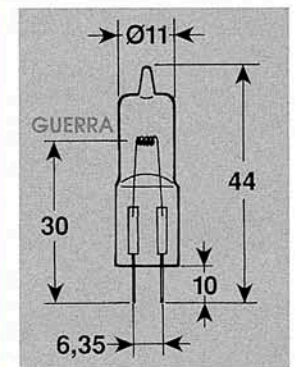
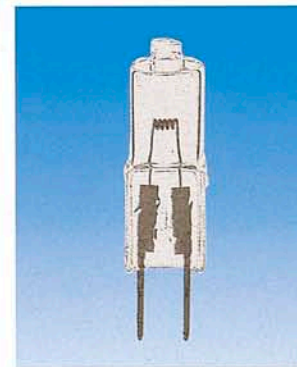

ART. No. ART. No. BEST. NR. CODICE	TYPE REF. TYP TIPO	VOLTAGE VOLTS VOLTS VOLT	WATTAGE WATTS WATTS WATT	BASE CULOT SOCKET BASE	LUMENS LUMENS LUMENS LUMEN.	LIFE DUREE LEBENSDAUER DURATA	QV/PACK PIECES/CARTON STK/KARTON IMB.	FIG. No. FIG. No. BILD NR. FIG. n.
--	------------------------------------	--	--	--	---	---	---	--

7111/1	-	6	15	BA9S	110	100	10	1
--------	---	---	----	------	-----	-----	----	---

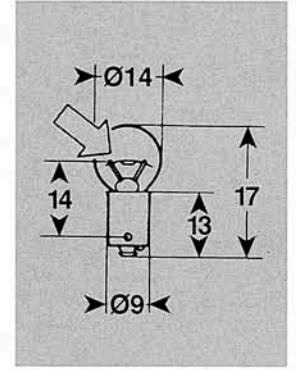
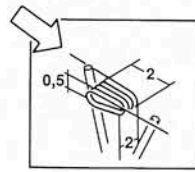

7113/1	-	6	6	BA9S	70	500	10	2
7713/SM	-	6	6	BA9S	60	500	10	2

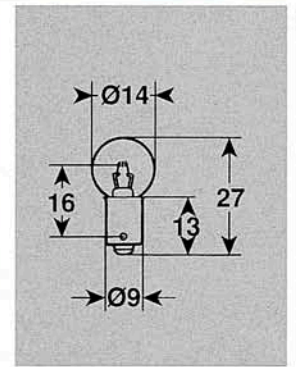

7114/1	-	6	3	E10	30	500	10	3
7114/SM	-	6	5	E10	55	500	10	3
7114/3	-	6	5	E10	60	500	10	3
7114/4	-	6	6	E10	70	500	10	3
7114/5	-	8	10	E10		500	10	3

7115/1	-	12	3	E10	22	500	10	3
7115/SM	-	12	3	E10	20	500	10	3

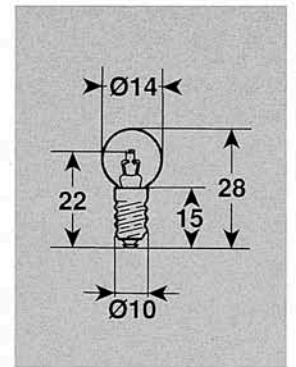

7116/H	HESS	3,5	-	E10	-	500	10	4
--------	------	-----	---	-----	---	-----	----	---

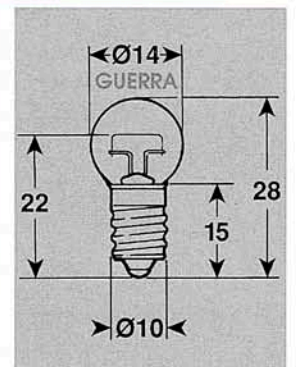

7409/2	-	6	6	E12M	70	500	10	5
--------	---	---	---	------	----	-----	----	---

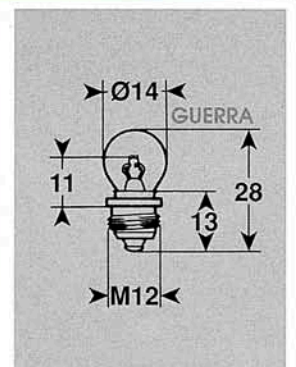
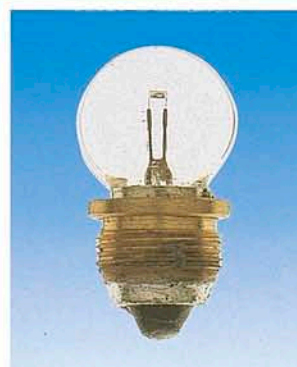

ART. No. ART. No. BEST. NR. CODICE	TYPE REF. TYP TIPO	VOLTAGE VOLTS VOLTS VOLT	WATTAGE WATTS WATTS WATT	BASE CULOT SOCKET BASE	LUMENS LUMENS LUMENS LUMEN.	LIFE DUREE LEBENSDAUER DURATA	QY/PACK PIECES/CARTON STK/KARTON IMB.	FIG. No. FIG. No. BILD NR. FIG. n.
---	-----------------------------	-----------------------------------	-----------------------------------	---------------------------------	--------------------------------------	--	--	---

7500/1	-	6	15	E10	110	100	10	6
--------	---	---	----	-----	-----	-----	----	---

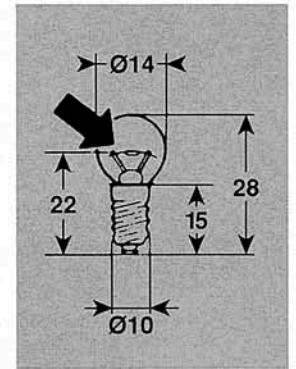
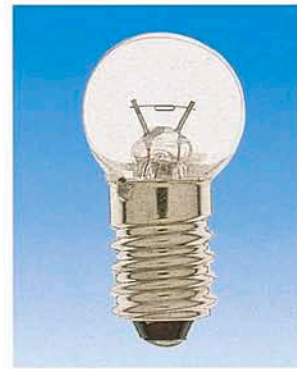
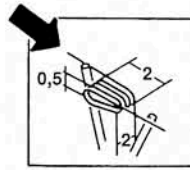

7501/2	-	6	15	BA9S	110	100	10	7
--------	---	---	----	------	-----	-----	----	---

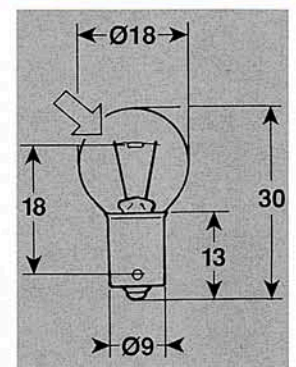
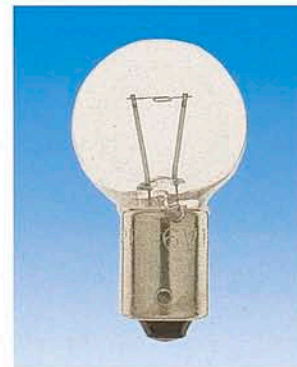
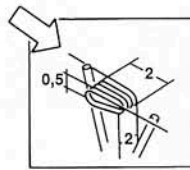

7502/H	-	6	10	E10	140	200	10	8
--------	---	---	----	-----	-----	-----	----	---

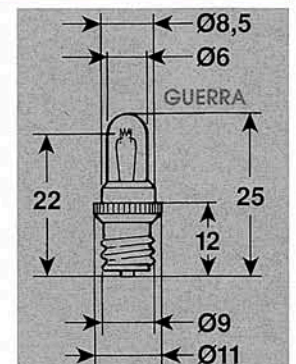
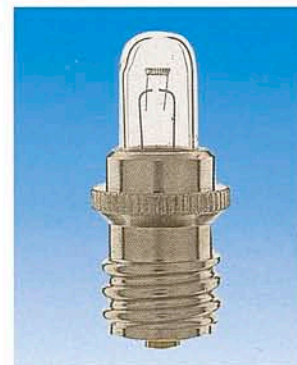

7503/H	-	12	10	BA9S	200	240	10	9
7504/H	-	12	20	BA9S	470	240	10	9
7505/H	-	12	20	BA9S	600	100	10	9
7506/H	-	12	20	BA9S	300	2000	10	9

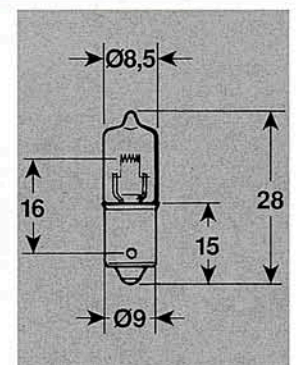
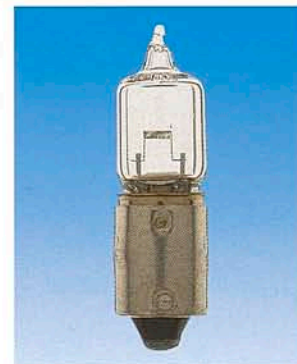

7507/H	-	6	20	G4	450	100	10	10
--------	---	---	----	----	-----	-----	----	----

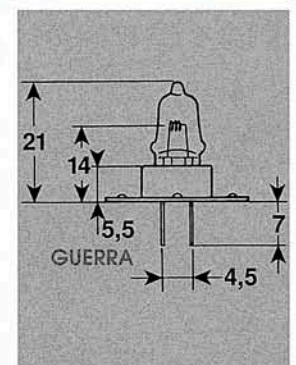
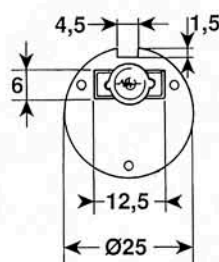

Q[®] **GUERRA**
www.lampsguerra.com

Q[®] **GUERRA**
www.lampsguerra.com

Q[®] **GUERRA**
www.lampsguerra.com

**LAMPADE PER VIDEOENDOSCOPIA, LAPAROSCOPIA,
MICROSCOPIA, FOTOTERAPIA, LAMPADE GERMICIDA
E PORTALAMPADE.**



**BULBS FOR VIDEO ENDOSCOPY, LAPAROSCOPY, MICROSCOPY AND
PHOTOTHERAPY. GERMICIDAL BULBS AND LAMP HOLDERS.**

**LAMPES POUR VIDEO ENDOSCOPIE, LAPAROSCOPIE, MICROSCOPIE ET
PHOTOTHERAPIE. LAMPES GERMICIDES ET DOUILLES.**

**LAMPEN FÜR VIDEO ENDOSKOPIE, LAPAROSKOPIE, MIKROSKOPIE,
PHOTOTHERAPIE, ENTKEIMUNGSLAMPEN UND FASSUNGEN.**

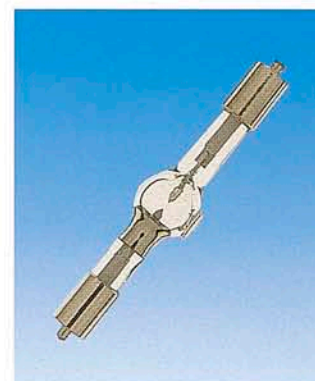
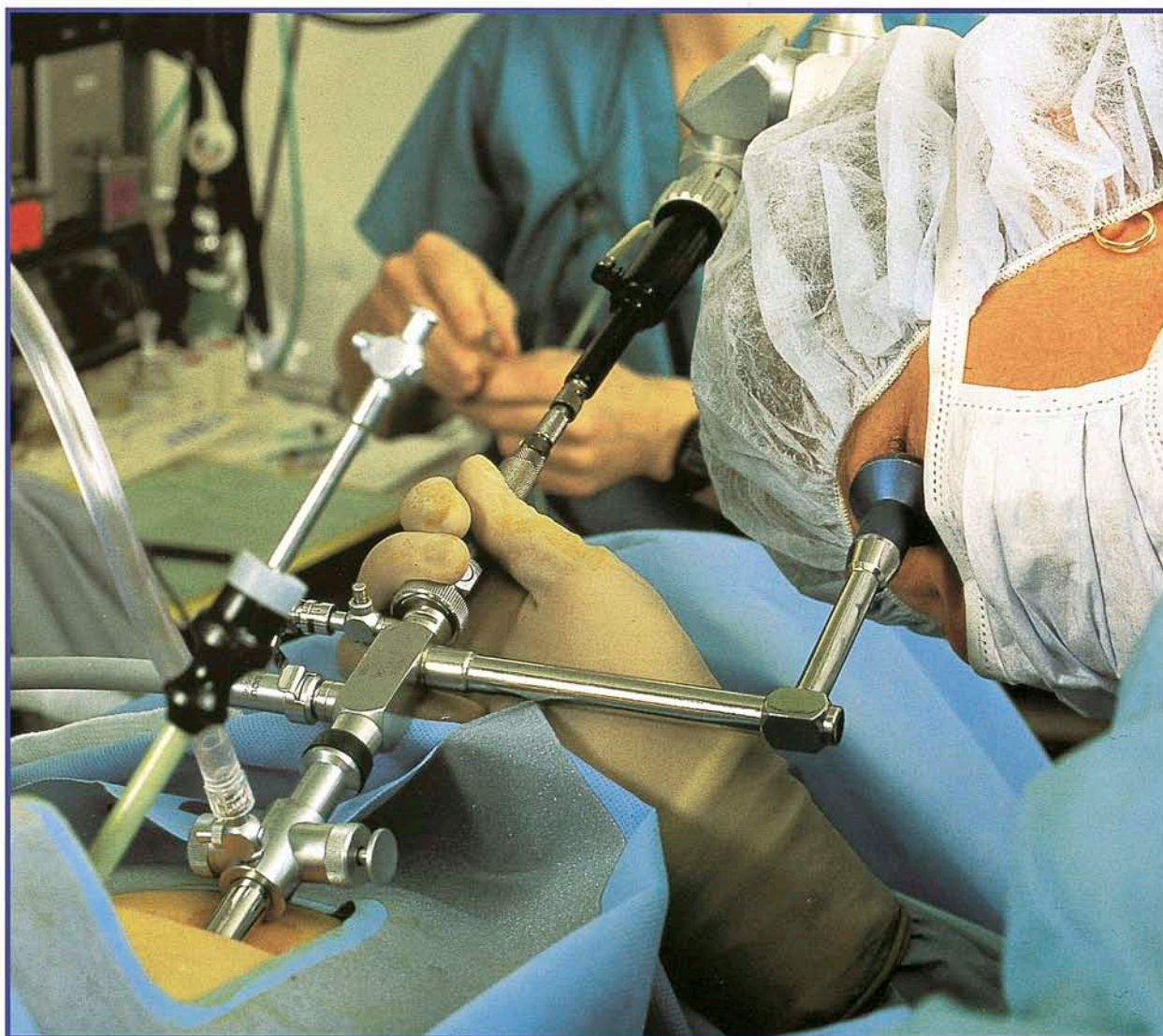

Q[®] **GUERRA**
www.lampsguerra.com

Q[®] **GUERRA**
www.lampsguerra.com

Q[®] **GUERRA**
www.lampsguerra.com

ART. No. ART. No. BEST. NR. CODICE	TYPE REF. TYP TIPO	VOLTAGE VOLTS VOLTS VOLT	WATTAGE WATTS WATTS WATT	BASE CULOT SOCKET BASE	LUMENS LUMENS LUMENS LUMEN.	LIFE DUREE LEBENSDAUER DURATA	QY/PACK PIECES/CARTON STK/KARTON IMB.	FIG. No. FIG. No. BILD NR. FIG. n.
5030/1	EZG	35	300	SPEC.	-	75	1	1

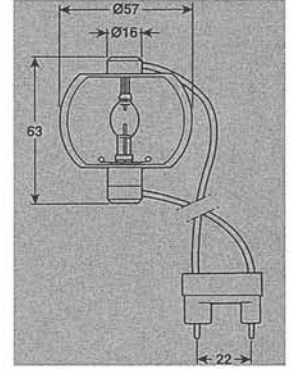

5030/2	EZM	37,5	300	SPEC.	-	25	1	2
--------	-----	------	-----	-------	---	----	---	---

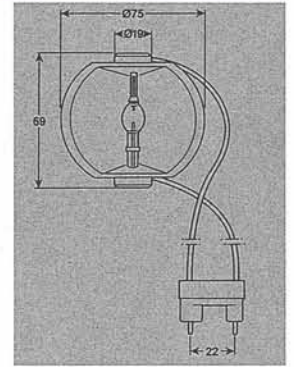

250/32C	HT I	45	270	SPEC.		250	1	3
250/22C	HT I	45	270	SPEC.		250	1	3
403/24C	HT I	55	400	SPEC.		750	1	3
100/45C	XBO R	14	100	SPEC.		500	1	3

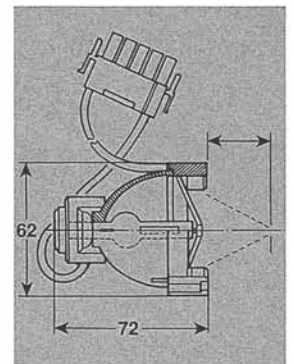
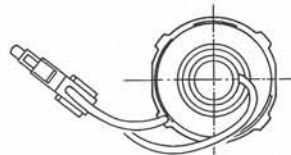

250/32	HT I	45	270	-		250	1	4
250/22	HT I	45	270	-		250	1	4
400/24	HT I	55	400	-		250	1	4
100/45	XBO R	14	100	-		500	1	4

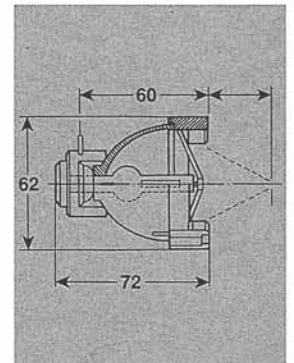
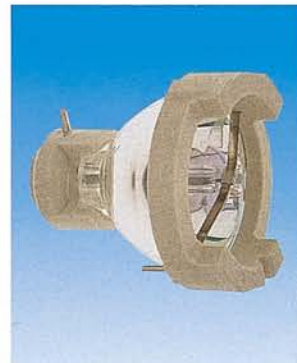
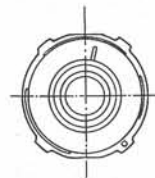

HT I = LAMPAD E A VAPORI DI ALOGENURI METALLICI/METAL HALIDE LAMPS/LAMPES AUX VAPEURS METALLIQUES/HALOGEN-METALLDAMPFLAMPEN
 XBO = LAMPAD E AD ARCO CORTO ALLO XENO/XENON SHORT ARC LAMPS/LAMPES XENON A ARC COURT/XENON-KURZBOGENLAMPEN

SPEC. = SPECIALE/SPECIAL/SONDER
 C. = CONNETTORE/CONNECTOR/CONNECTEUR/VERBINDER

ART. No. ART. No. BEST. NR. CODICE	TYPE REF. TYP TIPO	VOLTAGE VOLTS VOLTS VOLT	WATTAGE WATTS WATTS WATT	BASE CULOT SOCKET BASE	LUMENS LUMENS LUMENS LUMEN.	LIFE DUREE LEBENSDAUER DURATA	QY/PACK PIECES/CARTON STK/KARTON IMB.	FIG. No. FIG. No. BILD NR. FIG. n.
ORC 150	—	12	150	SPEC.	—	500	1	5
ORC 175 F	CLV-A	13	175	SPEC.	—	500	1	5
ORC 300 F	EMP 3000	14	300	SPEC.	—	500	1	5
ORC 1052	CLV-10	14	300	SPEC.	—	500	1	5
ORC 1064	CLV-F10	14	300	SPEC.	—	500	1	5
ORC 1064S	CLV-U20	14	300	SPEC.	—	500	1	5
ORC 300 FP	611-630	14	300	SPEC.	—	500	1	5



Compact Short Arc Xenon Lamps.

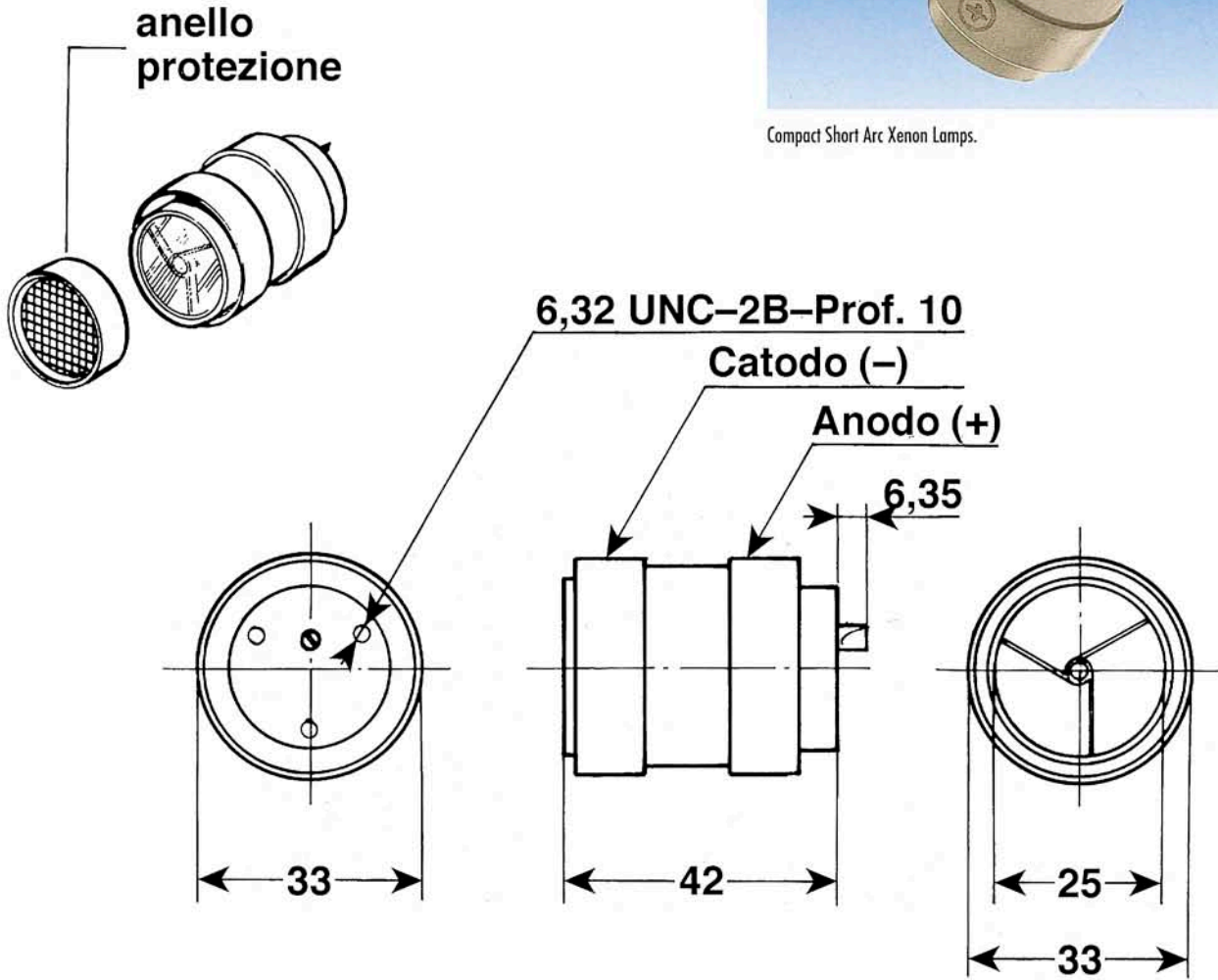

Figure 2: DEFINITION OF BEAM ANGLE

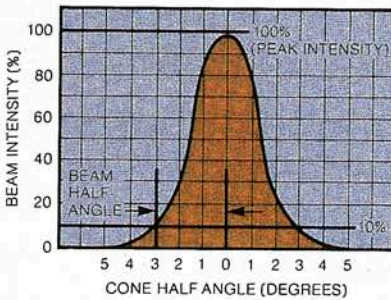

Figure 3: TYPICAL BEAM PROFILES

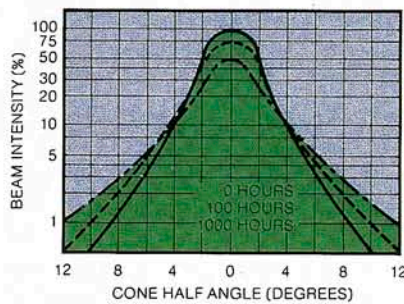
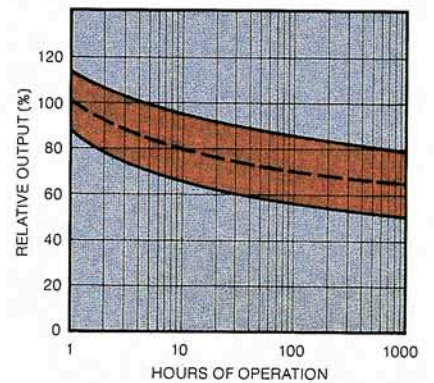

Figure 4: OUTPUT VS. TIME



ART. No. ART. No. BEST. NR. CODICE	TYPE REF. TYP TIPO	VOLTAGE VOLTS VOLTS VOLT	WATTAGE WATTS WATTS WATT	BASE CULOT SOCKET BASE	LUMENS LUMENS LUMENS LUMEN.	LIFE DUREE LEBENSDAUER DURATA	QY/PACK PIECES/CARTON STK/KARTON IMB.	FIG. No. FIG. No. BILD NR. FIG. n.
HBO	50W ACL1	39	50	SPEC.	2000	100	1	11
HBO	50W ACL2	34	50	SPEC.	2000	100	1	11
HBO	50W 3	22	50	SPEC.	1300	200	1	11



GUERRA

PRODUZIONE LAMPADE SPECIALI
PRODUCTION OF SPECIAL LAMPS
PRODUCTION D'AMPOULES SPECIALES
HERSTELLUNG VON SONDERLAMPEN

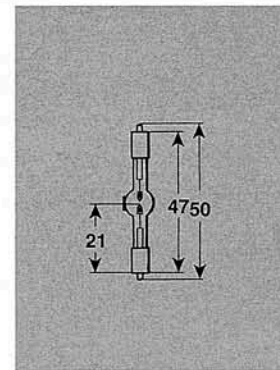
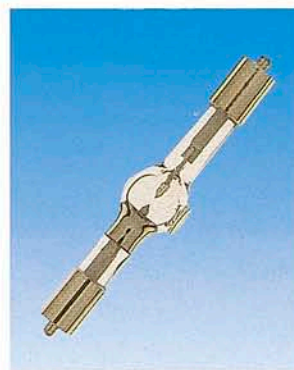

HBO	100 W1	20	100	SPEC.	2500	200	1	12
HBO	100 W2	20	100	SPEC.	2500	200	1	12
HBO	103 W/2	22	100	SPEC.	3100	300	1	12
XBO	75 W/2	14	75	SPEC.	1000	400	1	12
XBO	100 W	14	100	SPEC.	1800	500	1	12

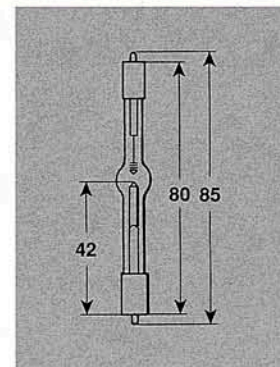

HBO	200W/2L1	61	200	SPEC.	10000	400	1	13
HBO	200W/2L2	65	200	SPEC.	10000	400	1	13
HBO	202W/4	75	270	SPEC.	9500	200	1	13
HBO	350 W	60	350	SPEC.	19500	400	1	13

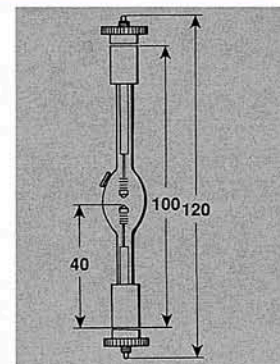

XBO	150W/1	20	150	SPEC.	3000	1200	1	14
-----	--------	----	-----	-------	------	------	---	----

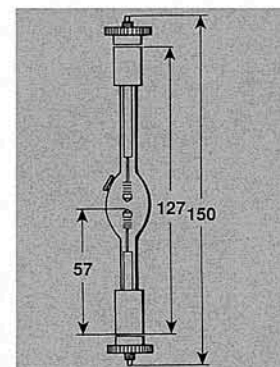

HBO = LAMPADE AD ARCO CORTO A VAPORI DI MERCURIO/MERCURY SHORT ARC LAMPS/LAMPES AUX VAPEURS DE MERCURE/QUECKSILBERDAMPF-KURZBOGENLAMPEN
XBO = LAMPADE AD ARCO CORTO ALLO XENO/XENON SHORT ARC LAMPS/LAMPES XENON A ARC COURT/XENON-KURZBOGENLAMPEN

SPEC. = SPECIALE/SPECIAL/SONDER

ART. No. ART. No. BEST. NR. CODICE	TYPE REF. TYP TIPO	VOLTAGE VOLTS VOLTS VOLT	WATTAGE WATTS WATTS WATT	BASE CULOT SOCKET BASE	LUMENS LUMENS LUMENS LUMEN.	LIFE DUREE LEBENSDAUER DURATA	QY/PACK PIECES/CARTON STK/KARTON IMB.	FIG. No. FIG. No. BILD NR. FIG. n.
--	------------------------------------	--	--	--	---	---	---	--

UV 1	UV	220	250	SPEC.	-	500	1	6
------	----	-----	-----	-------	---	-----	---	---

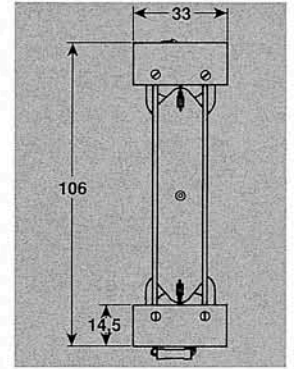
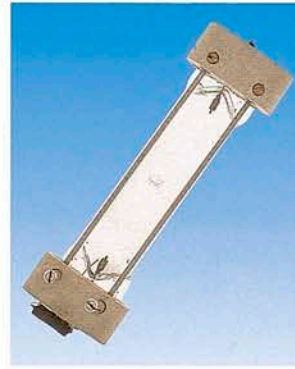
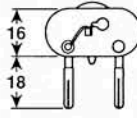

UV 2	S 300 C	A	300	SPEC.	-	500	1	7
UV 3	S 500 C	A	500	SPEC.	-	500	1	7

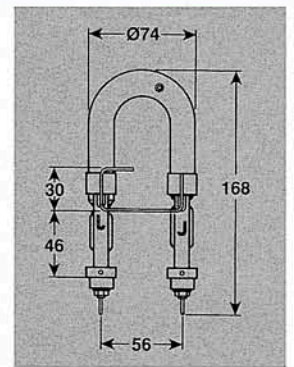
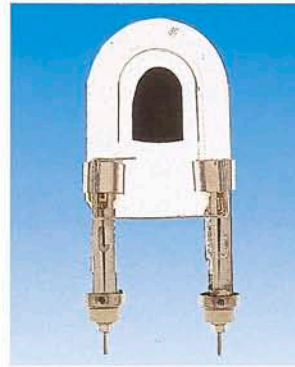

Q402 Z7	UV	A	402	R7S	-	500	1	8
---------	----	---	-----	-----	---	-----	---	---

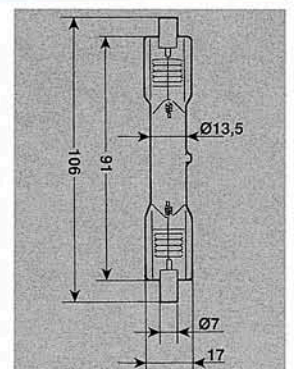
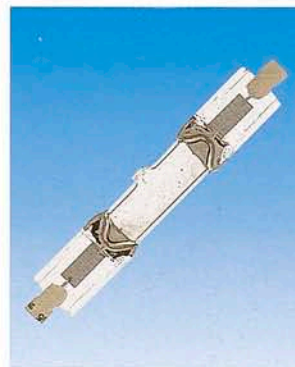

E402	UV	A	402	E40	-	500	1	9
------	----	---	-----	-----	---	-----	---	---

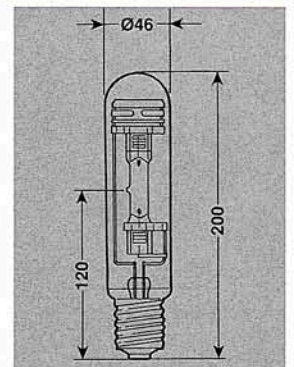
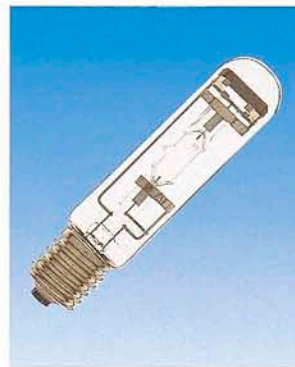

FC	300771	A	FF4	SPEC.	-	-	1	10
----	--------	---	-----	-------	---	---	---	----

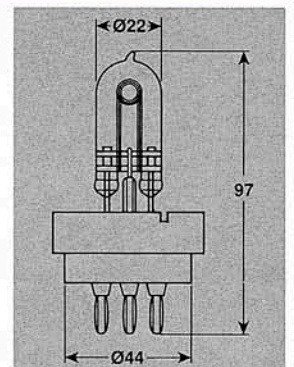
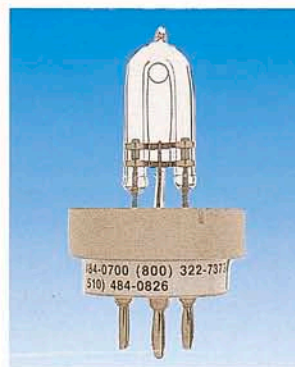
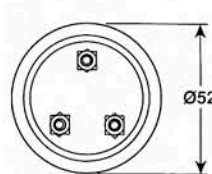

FC = FUNDUS CAMERA

SPEC. = SPECIALE/SPECIAL/SONDER
A. = ACCENDITORE/IGNITER/ALLUMEUR/ZÜNDER

ART. No. ART. No. BEST. NR. CODICE	TYPE REF. TYP TIPO	VOLTAGE VOLTS VOLTS VOLT	WATTAGE WATTS WATTS WATT	BASE CULOT SOCKET BASE	D x L	LIFE DUREE LEBENSDAUER DURATA	QY/PACK PIECES/CARTON STK./KARTON IMB.	FIG. No. FIG. No. BILD NR. FIG. n.
---	-----------------------------	-----------------------------------	-----------------------------------	---------------------------------	-------------	--	---	---



PRODUZIONE LAMPADE SPECIALI
PRODUCTION OF SPECIAL LAMPS
PRODUCTION D'AMPOULES SPECIALES
HERSTELLUNG VON SONDERLAMPEN

LAMPADE GERMICIDA - GERMICIDAL LAMPS UV 253,7 nm.

G4T5		—	4	G5	15x134	3000	6	1
G6T5		—	6	G5	15x210	3000	6	1
G8T5		—	8	G5	15x286	3000	6	1
G15T8		—	15	G12	24x435	3000	6	1
G30T8		—	30	G12	24x893	3000	6	1

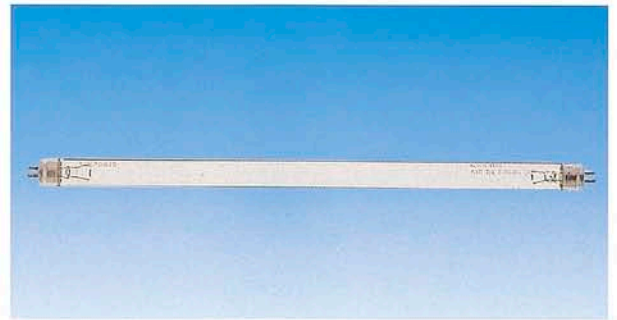
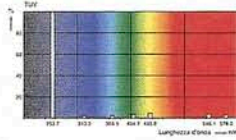

ATTINICHE/ACTINIC LAMPS 300 ÷ 460 nm.

TL 20W/05		—	20	G13	38x590	3000	6	2
TL 40W/05		—	40	G13	40x1200	3000	6	2

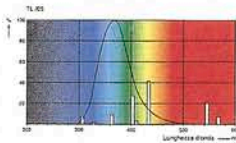

SUPER ATTINICHE/SUPER ACTINIC LAMPS 380 ÷ 460 nm.

TL 20W/03		—	20	G13	38x590	3000	6	3
TL 40W/03		—	40	G13	38x1200	3000	6	3
F20T12/BB		—	20	G13	38x590	3000	6	3
F40 BB		—	40	G13	38x1200	3000	6	3

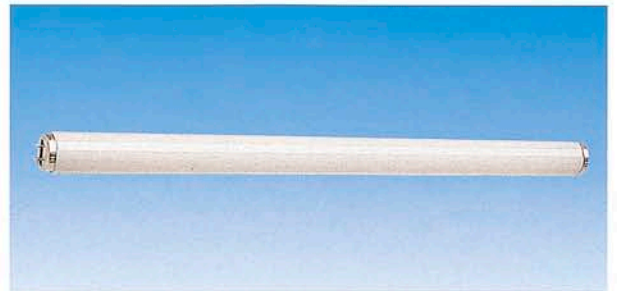
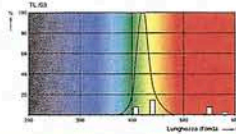

ATTINICHE «UVA»/ACTINIC «UVA» 320 ÷ 390 nm.

TL 36025/09N		—	26	G13	25x360	3000	6	4
TL 44025/09N		—	20	G13	25x440	3000	6	4
TL 20W/09N		—	20	G13	38x590	3000	6	4

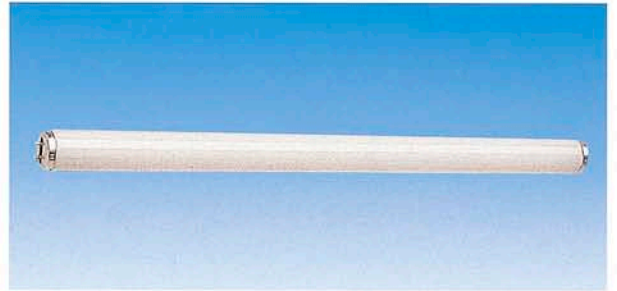
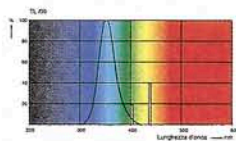

LUCE NERA IN VETRO DI WOOD/WOOD BLACK LIGHT 330 ÷ 380 nm.

TL 4W/08		—	4	G5	16x150	3000	6	5
TL 6W/08		—	6	G5	16x212	3000	6	5
TL 8W/08		—	8	G5	16x300	3000	6	5
TLD 18W/08		—	18	G13	26x590	3000	6	5
TLD 36W/08		—	36	G13	26x1200	3000	6	5

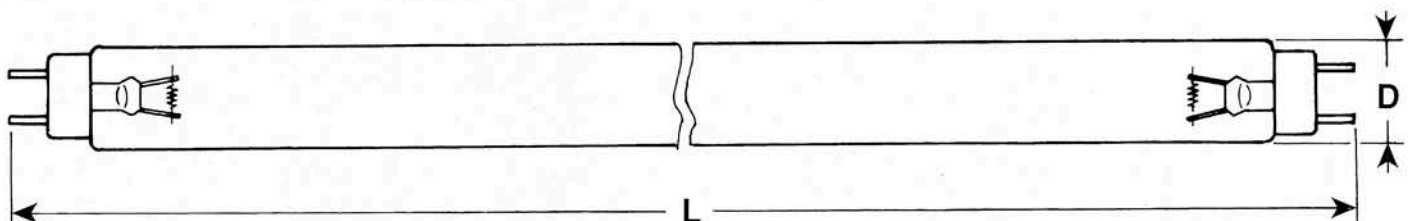
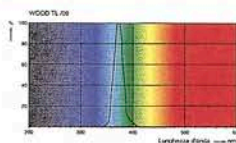

ART. No. ART. No. BEST. NR. CODICE	TYPE REF. TYP TIPO	VOLTAGE VOLTS VOLTS VOLT	WATTAGE WATTS WATTS WATT	BASE CULOT SOCKET BASE	LUMENS LUMENS LUMENS LUMEN.	LIFE DUREE LEBENSDAUER DURATA	QY/PACK PIECES/CARTON STK/KARTON IMB.	FIG. No. FIG. No. BILD NR. FIG. n.
P10/N 10A.	G6,35 T.160°C			G. 6,35			10	1

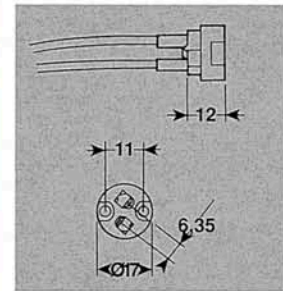

P11/C 10A.	G6,35 T.180°C			G. 6,35			10	2
---------------	------------------	--	--	---------	--	--	----	---

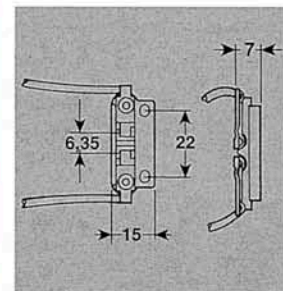
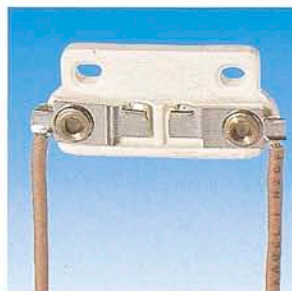

P12/M 12,5A.	G6,35 T.230°C			G. 6,35			10	3
-----------------	------------------	--	--	---------	--	--	----	---

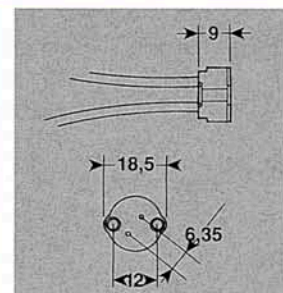

P13/M 10A.	G4 T.180°C			G. 4			10	4
---------------	---------------	--	--	------	--	--	----	---

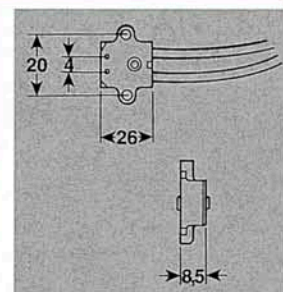

P15/C 12A.	BA15D T.280°C			BA15D			10	5
---------------	------------------	--	--	-------	--	--	----	---

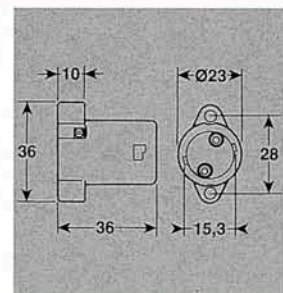

P16/M 12,5A.	G6,35 T.250°C			G. 6,35 GY6,35			10	6
-----------------	------------------	--	--	-------------------	--	--	----	---

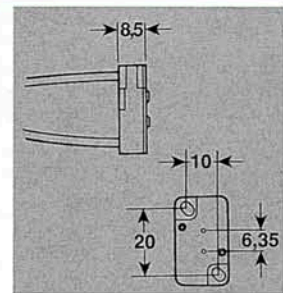

A = AMPERE/AMPER
T = TEMPERATURA/TEMPERATURE/TEMPERATUR
°C = GRADI CENTIGRADI/DEGREES CENTIGRADE/CELSIUSGRADE

ART. No. ART. No. BEST. NR. CODICE	TYPE REF. TYP TIPO	VOLTAGE VOLTS VOLTS VOLT	WATTAGE WATTS WATTS WATT	BASE CULOT SOCKET BASE	LUMENS LUMENS LUMENS LUMEN.	LIFE DUREE LEBENSDAUER DURATA	QY/PACK PIECES/CARTON STK/KARTON IMB.	FIG. No. FIG. No. BILD NR. FIG. n.
P17C	GY9,5			GY9,5			10	7
16A.	T.230°C							

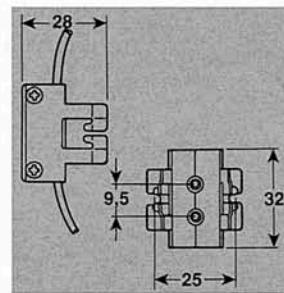

HS-300	G.5,3-GX5,3			G.5,3			10	8
10A.	T.250°C			GX5,3				
HS-310	G.6,35-GY6,35			G.6,35			10	8
10A.	T.250°C			GY6,35				

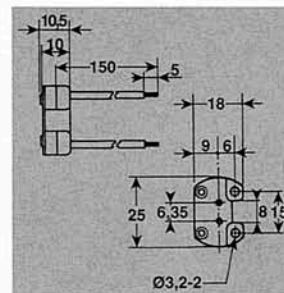

HS-600	E10			E10			10	9
10A.	T.250°C							
HS-700	E11			E11			10	9
10A.	T.250°C							

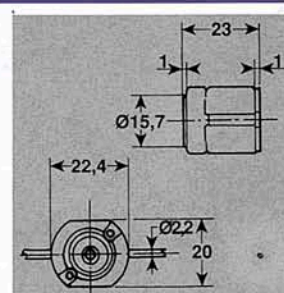

HS-610	E10			E10			10	10
10A.	T.250°C							
HS-710	E11			E11			10	10
10A.	T.250°C							

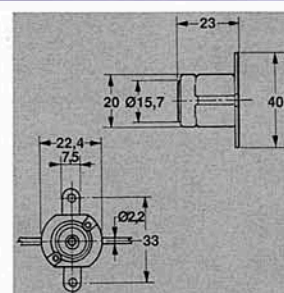

QLV/0	MR16 Ø50 mm.			MR16			10	11
-------	--------------	--	--	------	--	--	----	----

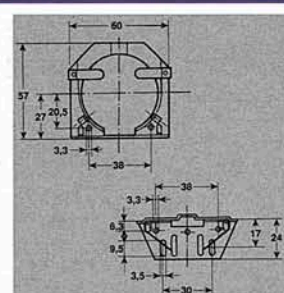

QLV/1	MR16 Ø50 mm.			GZ 5,3			10	12
10A.	GZ 5,3							
QLV/2	MR16 Ø50 mm.			GZ 6,35				
10A.	GZ 6,35							

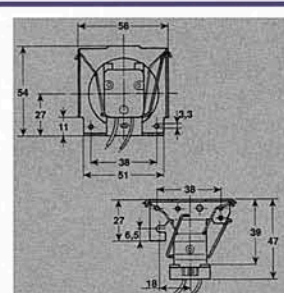
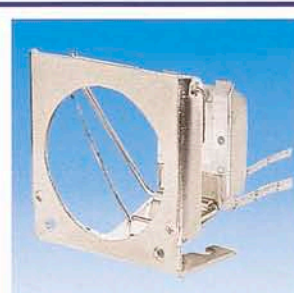

A = AMPERE/AMPER
T = TEMPERATURA/TEMPERATURE/TEMPERATUR
°C = GRADI CENTIGRADI/DEGREES CENTIGRADE/CELSIUSGRADE

Q[®] **GUERRA**
www.lampsguerra.com

Q[®] **GUERRA**
www.lampsguerra.com

Q[®] **GUERRA**
www.lampsguerra.com

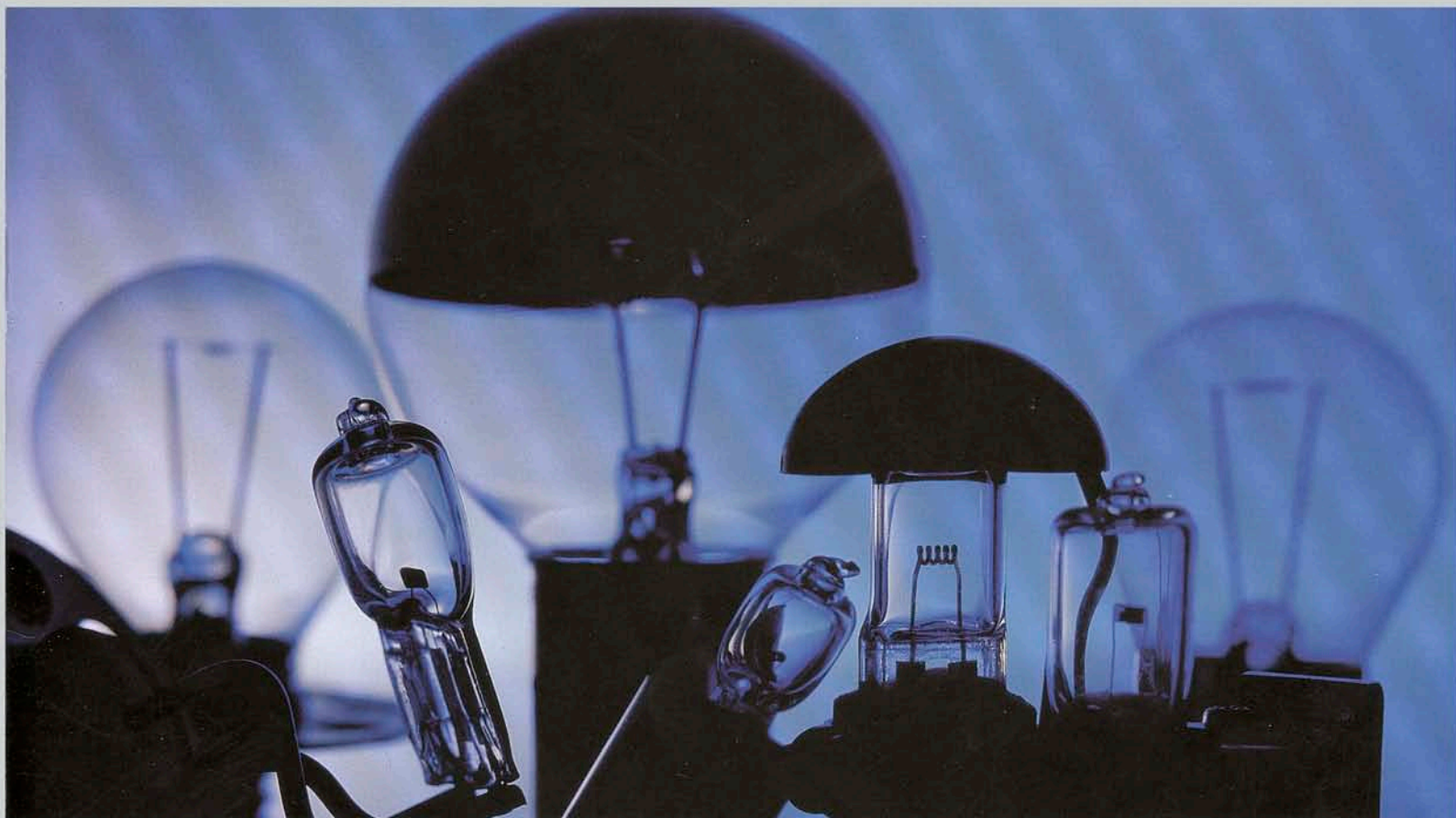

**PRODUZIONE LAMPAD E SPECIALI ALOGENE E AD
INCANDESCENZA PER USO MEDICO OSPEDALIERO**

PRODUCTION OF SPECIAL HALOGEN AND INCANDESCENT LAMPS FOR HOSPITAL MEDICAL APPLICATION
PRODUCTION D'AMPOULES SPECIALES HALOGENES ET INCANDESCENTES POUR USAGE HOSPITALIER ET MEDICAL
HERSTELLUNG VON SONDER-HALOGEN UND GLÜHLAMPEN FÜR MEDIZINISCHE BEREICH UND KRANKENHÄUSER

**GUERRA**
www.lampsguerra.com

LAMPADRE SPECIALI PER USO MEDICO OSPEDALIERO

LA NOSTRA AZIENDA VANTA ANNI DI ESPERIENZA NELLA PRODUZIONE DI LAMPADRE PER GRUPPI OTTICI AD USO MEDICO OSPEDALIERO QUALI: MICROSCOPI, ENDOSCOPI, OFTALMOSCOPI, SCIALITICHE... E QUALSIASI ALTRA APPARECCHIATURA UTILIZZI UNA FONTE LUMINOSA.

LA CURA ARTIGIANALE E L'ATTENZIONE AL PARTICOLARE ASSICURANO ALLE NOSTRE LAMPADRE UN'OTTIMA QUALITÀ E CI CONSENTONO DI PRODURRE, OLTRE AGLI ARTICOLI STANDARD PRESENTI A CATALOGO, LAMPADRE SPECIALI CON CARATTERISTICHE TECNICHE FORNITE DAL CLIENTE (QUALORA I QUANTITATIVI RICHIESTI LO GIUSTIFICHIANO).

INOLTRE DISPONIAMO DI LAMPADRE PER USO FOTOGRAFICO, OTTICO, AEREOPORTUALE E PER PROIEZIONI SPECIALI DELLE PIÙ IMPORTANTI MARCHE.

IL NOSTRO PERSONALE È A VOSTRA DISPOSIZIONE PER FORNIRVI OGNI ULTERIORE INFORMAZIONE.

SPECIAL LAMPS FOR HOSPITAL MEDICAL APPLICATION

WE HAVE A LONG EXPERIENCE IN MANUFACTURING AND SELLING BULBS FOR ALL SORTS OF MEDICAL EQUIPMENTS.

THE PARTICULAR CARE AND CRAFTSMANSHIP WE GIVE TO OUR PRODUCTION ALLOW US TO MAINTAIN HIGH QUALITY LEVELS BOTH FOR OUR STANDARD ARTICLES, SHOWN ON THIS CATALOGUE, AND FOR THE SPECIAL LAMPS WE MANUFACTURE ACCORDING TO OUR CUSTOMERS' TECHNICAL FEATURES.

WE ALSO HAVE AVAILABLE BULBS FOR PHOTOGRAPHIC, OPTICAL, AIRPORT APPLICATION AND FOR SPECIAL PROJECTION. OUR STAFF IS AT YOUR DISPOSAL FOR ANY FURTHER INFORMATION YOU MAY NEED.

PRODUCTION D'AMPOULES SPECIALES POUR USAGE HOSPITALIER ET MEDICAL

NOUS AVONS UNE GRANDE EXPÉRIENCE DE LA PRODUCTION ET LA VENTE D'AMPOULES POUR TOUTS LES TYPES D'ÉQUIPEMENTS MÉDICALES.

LE SOIN PARTICULIER ET L'ATTENTION AUX DÉTAILS DONNENT À NOS AMPOULES UNE QUALITÉ SUPÉRIEURE ET NOUS PERMETTENT DE PRODUIRE, À PART LES ARTICLES STANDARD, QUI SONT PRÉSENTÉS DANS CE CATALOGUE, AMPOULES SPECIALES SELONS LES CARACTÉRISTIQUE TECHNIQUES SOUHAITÉES PAR NOS CLIENTS.

DE PLUS NOUS DISPOSONS D'AMPOULES POUR USAGE PHOTOGRAPHIQUE, OPTIQUE, D'AÉROPORT ET POUR PROJECTIONS SPECIALES, DES PLUS IMPORTANTES MARQUES. NOTRE PERSONNEL EST À VOTRE DISPOSITION POUR VOUS ADRESSER D'AUTRES INFORMATIONS.

HERSTELLUNG VON SONDERLAMPEN FÜR MEDIZINISCHE BEREICH UND KRANKENHÄUSER

WIR HABEN GROßE ERFAHRUNG IN DER HERSTELLUNG UND IN DEM VERTRIEB VON LAMPEN FÜR SÄMTLICHE MEDIZINISCHE AUSRÜSTUNGSARTEN.

DIE BESONDERE PFLEGE UND DIE AUFMERKSAMKEIT BEI DEN EINZELHEITEN MACHEN UNSERE LAMPEN ERSTKLASSIGE PRODUKTE UND ERLAUBEN UNS, NEBEN DEN STANDARDLAMPEN, DIE IN DIESEM KATALOG GEZEIGT WERDEN, AUCH SONDERLAMPEN GEMÄß DEN TECHNISCHEN DATEN UNSEREN KUNDEN ZU FERTIGEN.

AUßERDEM VERFÜGEN WIR ÜBER PHOTO-, OPTIK-, FLUGHAFENS- UND SONDERPROJEKTIONS-LAMPEN DER WICHTIGSTEN HERSTELLERFIRMEN. UNSER PERSONAL BLEIBT ZU IHRER VERFÜGUNG FÜR WEITERE ERKLÄRUNGEN.

IL NOSTRO MAGAZZINO CONTIENE UNO STOCK DI OLTRE CENTOMILA LAMPADE
ACCURATAMENTE IMBALLATE IN CONFEZIONI STANDARD.

IL FAX È IN FUNZIONE 24 ORE SU 24 PER SODDISFARE LE ESIGENZE DELLA
CLIENTELA IN TEMPI BREVI.

SIAMO IN GRADO DI GARANTIRE LA CONSEGNA DELLA MERCE ENTRO 48 ORE IN
TUTTA EUROPA, AVVALENDOCI DI CORRIERI ESPRESSI CONOSCIUTI ED
AFFIDABILI.

OUR WAREHOUSE STOCKS
MORE THAN A HUNDRED
THOUSAND BULBS WHICH ARE
VERY CAREFULLY PACKED IN
STANDARD BOXES.

DANS LE NOTRE MAGASIN IL-Y-A
UN DÉPÔT DE PLUS DE CENT
MILLE LAMPES
SOIGNEUSEMENT EMBALLÉE
DANS DES CONFECTIONS
STANDARD.

IN UNSEREM LAGER GIBT ES
ÜBER HUNDERTTAUSEND
LAMPEN, DIE IN STANDARD
VERPACKUNGEN SORGFÄLTIG
GEPACKT SIND.

OUR FAX MACHINE WORKS 24
HOURS A DAY IN ORDER TO
SATISFY OUR CUSTOMERS'
REQUIREMENTS IN SHORT
TIME.

NOS FAX EST OPERATIF 24H SUR
24 POUR SATISFAIRE TOUS LES
BESOIN DU CLIENT A COURT
ÉCHÉANCE.

DAS FAXMASCHINE
FUNKTIONIERT RUND UM DIE
UHR UM UNSERES KUNDEN
BEDÜRFNISSES IN KURZEN
ZEIT ZU BEFRIEDIGEN.

WE ARE IN A POSITION TO
DELIVER OUR GOODS
TROUGHTOUT EUROPE BY
MEANS OF WELL-KNOWN AND
RELIABLE EXPRESS COURIERS
WITHIN 48 HOURS.

NOUS ASSURONS LA REMISE DE
MERCHANDISE DANS LE 48
HEURES EN TOUTE EUROPE,
FAISANT USAGE DES
EXPEDIER EXPRESS CONNU ET
CERTAIN.

WIR KÖNNEN EINE
LIEFERUNG DER WARE IN DEN
GANZEN EUROPA IN 48
STUNDEN DURCH BERÜHMTE
UND ZUVERLÄSSIGE
EXPRESFRACHTER
VERSICHERN.

© VIETATA LA RIPRODUZIONE, ANCHE PARZIALE DI QUESTO STAMPATO. PROPRIETÀ DELLA DITTA GUERRA - ITALIA. SENZA AUTORIZZAZIONE SCRITTA DELLA STESSA IL PRESENTE STAMPATO NON POTRÀ ESSERE RIPRODOTTO. LA SOCIETÀ PROPRIETARIA TUTELA I PROPRI DIRITTI A RIGORE DI LEGGE.

© ALL RIGHTS RESERVED, EVEN FOR PARTIAL REPRODUCTION OF THIS CATALOGUE. PROPERTY OF GUERRA - ITALIA. WITHOUT WRITTEN PERMIT OF IT, THIS CATALOGUE CANNOT BE REPRODUCED. THE PROPRIETOR COMPANY PROTECTS ITS RIGHTS ACCORDING TO LAW.

© REPRODUCTION INTERDITE, MÊME SI PARTIALE DE CE CATALOGUE. PROPRIÉTÉ DE LA FIRME GUERRA - ITALIA. SANS AUTORISATION ÉCRITE, CE CATALOGUE NE PEUT PAS ÊTRE REPRODUIT. LA FIRME PROPRIÉTAIRE PROTÈGE SES DROIT SELON LA LOI.

© NACHDRUCK VERBOTEN VON DIESEM KATALOG, AUCH WENN PARTIAL. EIGENTUM VON DER FIRMA GUERRA - ITALIA. OHNE SCHRIFTLICHE GENEHMIGUNG DERSELBEN FIRMA, KANN DIESER KATALOG NICHT NACHGEDRUCKT WERDEN. DIE BESITZERFIRMA SCHÜTZT IHRE RECHTE GESETZMÄSSIG.

© COPYRIGHT 1997.

© MARCHIO REGISTRATO / REGISTERED TRADE-MARK / EINGETRAGENE SCHUTZMARKE / MARQUE DEPOSÉE.



Guerra s.a.s.

Via Chieri, 91/93 - P.O. BOX - 10022 Carmagnola (TO) Italy

TEL. 011.972.21.79 - 011.971.35.56

FAX 011.972.17.97 - 011.972.09.59

www.lampsguerra.com

E-MAIL : guerra@lampsguerra.com